

Resumen TFG

Introducción experimento:

La rugosidad de la superficie es un parámetro muy importante que afecta la calidad del componente y la vida útil de la herramienta, lo que afecta indirectamente al coste de fabricación del componente deseado.

En esta investigación, el efecto de tres parámetros de corte sobre la rugosidad de la superficie se investigará durante el fresado de punta de bola en un acero X37CrMoV51. Los tres parámetros de corte serán los siguientes: profundidad de corte, ancho de corte y velocidad de corte.

La metodología de superficie de respuesta (RSM) se utilizará para desarrollar un modelo matemático para predecir el acabado superficial, para las diferentes combinaciones de los parámetros de corte antes mencionados.

Los resultados de los ensayos obtenidos en un experimento llevado a cabo sobre la base de este plan fueron sometidos a evaluación de las condiciones de repetibilidad de la implementación de la experiencia. Requiere una comparación de los resultados de la varianza. La variación de los resultados de un experimento que se desvía en términos del valor de los otros puede indicar la experiencia atípica, tal experiencia se debe repetir. El criterio de Cochran fue adoptado como criterio para evaluar la repetibilidad de las condiciones experimentales, verificando la hipótesis de la varianza de repetibilidad. Los resultados de la investigación de valor de proceso, realizados sobre la base del plan de experiencia adoptado, permiten construir un modelo matemático del objeto.

Planificación y realización del experimento

Máquinas:

-Fresadora: HASS VF -1

Centro de mecanizado vertical; 208 x 406 x 508 mm, 40 cónicas, 30 hp (22,4 kW), 8100 rpm, cambiador de herramientas de carrusel de 20 estaciones, 1000 ipm (25,4 m / Min), módulo de detección de fallos de alimentación, memoria de programa de 1 GB, monitor LCD a color de 15 ", puerto USB, conmutador de llave de memoria, roscado rígido y sistema de refrigeración de inundación de 55 galones (208 litros)

- Talysurf CCI - Lite Non-contact 3D Profiler

El Talysurf CCI Lite es un tipo avanzado de interferómetro de medición. Utiliza un innovador algoritmo de correlación patentado para encontrar el pico de coherencia y la posición de fase de un patrón de interferencia producido por una unidad de exploración óptica de precisión.

Material:

Se utilizó el acero X38CrMoV51 como material de muestra. Es un acero de aleación de cromo-molibdeno para trabajo en caliente. El acero se utiliza para elementos de moldes para fundición a presión, herramientas de extrusión para aleaciones de bajo punto de fusión, insertos de matriz, troqueles, punzones, etc. También se utiliza en las partes cargadas de la prensa para la extrusión de tubos y varillas. Se requiere que el acero retenga sus propiedades a 600 ° C. Esto se consigue mediante el uso de tungsteno y molibdeno, como adiciones de aleación.

Composición química [%]						
C	Mn	Si	P	S	Cr	Mo
0,42	0,5	1,2	0,03	0,03	5,5	1,5

Modelo matemático:

Los modelos matemáticos utilizados en el experimento serán un diseño factorial completo con 3 factores y 3 niveles.

En estadística, un experimento factorial completo es un experimento cuyo diseño consiste en dos o más factores, cada uno con discretos valores o "niveles" posibles.

Un diseño factorial completo contiene todas las combinaciones posibles de un conjunto de factores.

El experimento:

El diseño de los experimentos se realizó mediante el diseño factorial, estáticamente (3n) completo (diseño Hartley). Los parámetros considerados en este experimento fueron: profundidad de corte (ap), ancho de corte (a) y velocidad de corte (v). Cada uno de ellos con tres niveles (tres valores diferentes).

VALUE	x ₁ Profundidad de corte P [mm]	x ₂ Velocidad V [mm/min]	x ₃ Ancho de corte a [mm]
+	0,3	1500	0,1
0	0,2	1000	0,075
-	0,1	500	0,05

Diseño factorial completo:

Expt. No.	Valores codificados			Valores		
	x ₁	x ₂	x ₃	x ₁ Depth of the cut aP [MPa]	x ₂ Speed V [mm/min]	x ₃ Width a [mm]
1	+	+	+	0,3	1500	0,1
2	+	-	-	0,3	500	0,05
3	-	+	-	0,1	1000	0,05
4	-	-	+	0,1	500	0,1
5	+	0	0	0,3	1000	0,075
6	-	0	0	0,1	1000	0,075
7	0	+	0	0,2	1500	0,075
8	0	-	0	0,2	500	0,075
9	0	0	+	0,2	1000	0,1
10	0	0	-	0,2	1000	0,05
11	0	0	0	0,2	1000	0,075

Los parámetros utilizados para describir la textura de la superficie fueron los siguientes:

- Altura cuadrada media cuadrada de la superficie
- Ssk - asimetría de distribución de altura
- Sku - kurtosis de distribución de altura
- Sp - altura máxima de los picos
- Sv - altura máxima de los valles
- Sz - altura máxima de la superficie
- Altura media aritmética de la superficie

Muestra del experimento.

Experiment No. 1 ($a_p = 0,3\text{mm}$, $V = 1500\text{mm/min}$, $a = 0,1\text{mm}$)

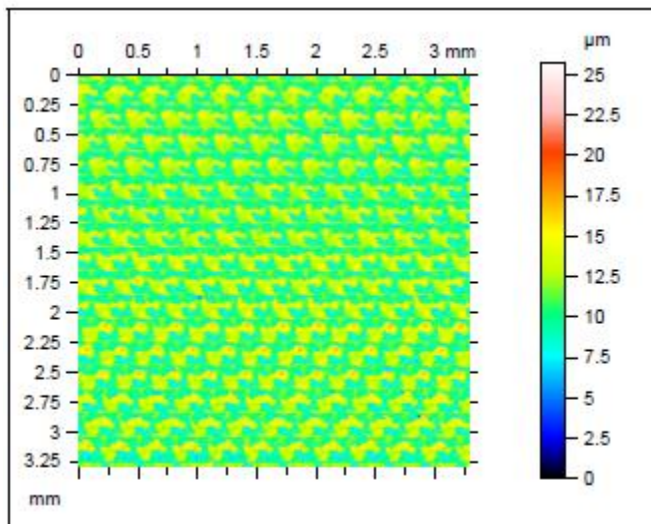

Parametry wysokości		
Sq	2.18	μm
Ssk	0.0281	
Sku	2.24	
Sp	14.4	μm
Sv	11.3	μm
Sz	25.7	μm
Sa	1.82	μm

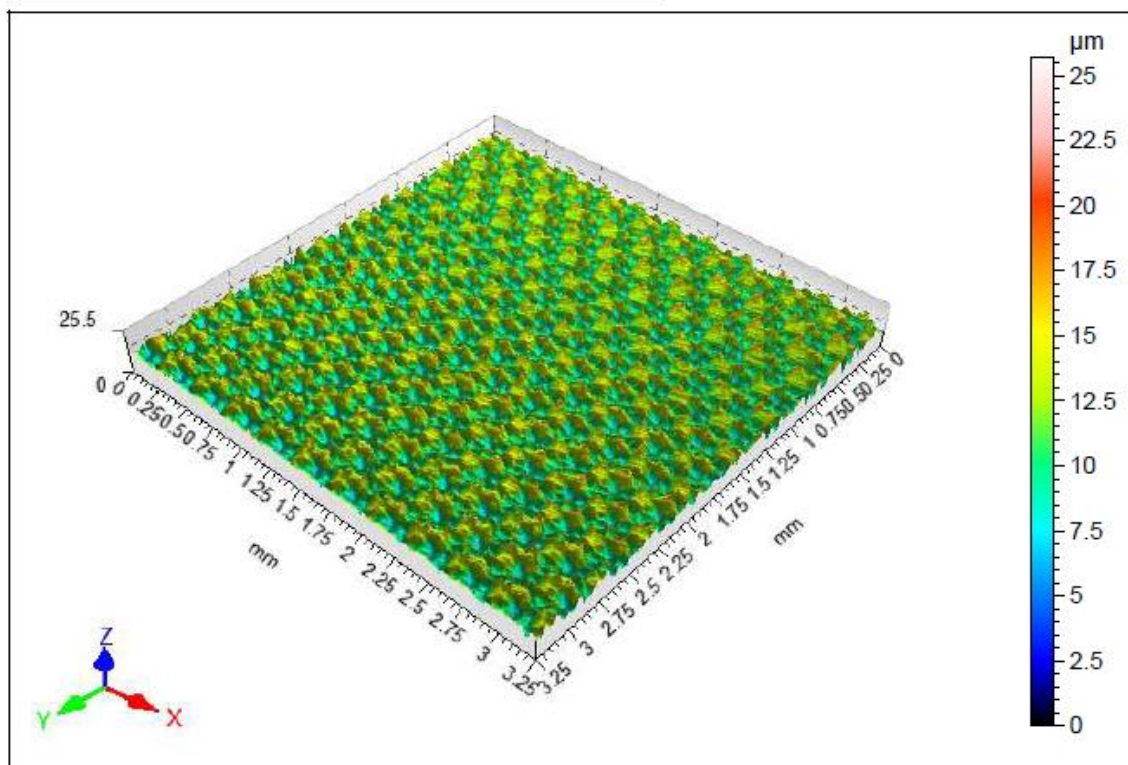

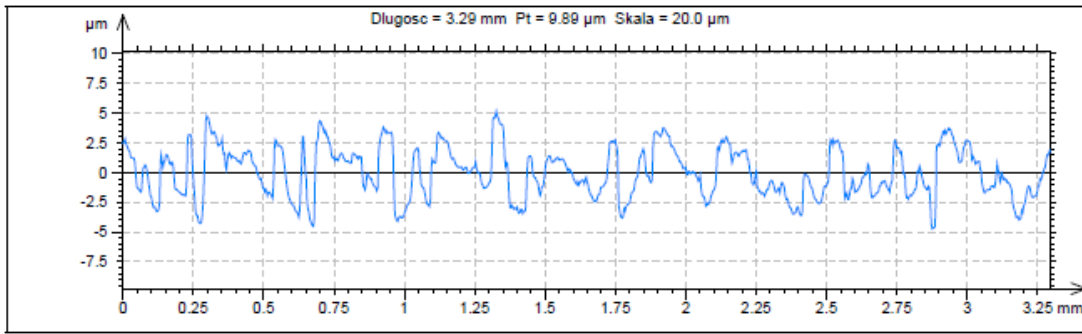

Cálculos (para cada muestra):

Se calcularon los coeficientes de regresión de las ecuaciones a partir de las fórmulas:

$$b_0 = \frac{a}{N} \sum_{i=1}^N \bar{y}_i - \frac{b}{N} \sum_{j=1}^k \sum_{i=1}^N x_{ji}^2 \bar{y}_i \quad b_k = \frac{1}{(\lambda_2 N)} \sum_{i=1}^N x_{ki} \bar{y}_i$$

$$b_{kl} = \frac{1}{(\lambda_3 N)} \sum_{i=1}^N x_{kli} \bar{y}_i$$

$$b_{kk} = \frac{c}{N} \sum_{i=1}^N x_{ki}^2 \bar{y}_i - \frac{b}{N} \sum_{i=1}^N \bar{y}_i - \frac{d}{N} \sum_{j=1}^k \sum_{i=1}^N x_{ji}^2 \bar{y}_i$$

Donde a, b, c, d son los coeficientes determinados a partir del Cuadro 7 dependiendo del número de factores de entrada, N - número de experimentos (sin repetición) k - el número de factores de entrada (encuestados).

Los coeficientes b_k y b_{kl} se calculan a partir de las fórmulas para los efectos de la interacción:

$$b_k = \frac{e}{N} \left(\sum_{i=1}^N x_{ki} \bar{y}_i - \sum_{i=1}^N x_{lmi} \bar{y}_i \right)$$

$$b_{kl} = \frac{f}{N} \sum_{i=1}^N x_{kl} \bar{y}_i - \frac{e}{N} \sum_{i=1}^N x_{mi} \bar{y}_i$$

La evaluación de la repetibilidad, las condiciones de la experiencia de implementación, la importancia de los coeficientes de regresión y la adecuación de la ecuación de regresión resultante han tenido en cuenta el hecho de que el valor de una prueba (empírica) t se calcula de acuerdo el contraste adoptado, que depende de las fórmulas utilizadas para calcular el valor de los coeficientes de regresión. Por lo tanto, cuando se utilizan valores empíricos de coeficientes para la prueba t , se calcula a partir de las siguientes fórmulas:

$$t_0 = \frac{|b_0|}{\sqrt{\frac{a}{rN} S^2(y)}}$$

$$t_k = \frac{|b_k|}{\sqrt{\frac{S^2(y)}{r(\lambda_2 N)}}$$

$$t_{kk} = \frac{|b_{kk}|}{\sqrt{\frac{c-d}{rN} S^2(y)}}$$

$$t_{ij} = \frac{|b_{ij}|}{\sqrt{\frac{S^2(y)}{r(\lambda_3 N)}}$$

Coefficientes t valor absoluto mayor que el valor determinado t_{kr} Tablica 4 [5] adoptado a un nivel de significación y grados de libertad $N = f(r - 1)$ se consideran significativos.

Análisis matemático para cada uno de los parámetros):

- 1- Cálculo de los valores medios.
- 2- Cálculo de la unidad de variación.
- 3- Factores de codificación.
- 4- Cálculo de los coeficientes de regresión.

- 5- Evaluación de las condiciones de reproducibilidad para la implementación del experimento.
- 6- Comprobación de la significación de los coeficientes de la ecuación.
- 7- Evaluación de la adecuación del modelo de investigación.
- 8- Ecuación de decodificación.

Ejemplo ecuación final de un parámetro:

$$Ssk = 13.3ap^2 + 570.4ap^2 + 0.00476apv - 225.6a^2 - 42790.69ap - \frac{427}{6250}av + 0.000001v^2 - 11.90928a + 5.122114v + 3431.516$$

Se verifica si $F < F_{Kr}$ en cada uno de los parámetros para ver si las ecuaciones de regresión obtenidas son adecuadas.

Las ecuaciones obtenidas para los parámetros: S_{ku} , S_p , S_v y S_z cumplen la condición expuesta anteriormente.

Conclusiones:

1. El método propuesto permite realizar estudios para analizar la importancia de los factores de impacto de la molienda de proceso de entrada X37CrMoV51 (profundidad de corte, velocidad de corte, ancho de corte) sobre la superficie acabada.
2. El modelo matemático resultante como resultado del plan Hartley permite la determinación de los parámetros seleccionados SGP a un nivel óptimo. Esto es de gran importancia, porque las superficies de alta calidad diseñadas o fabricadas determinan su eficiencia operativa mejorada, confiable y precisa interactúa con las superficies de otros elementos.
3. Conocimiento del modelo matemático del proceso de prueba para los parámetros seleccionados El SGP permite predecir su curso y comportamiento en diferentes condiciones. Los parámetros de entrada pueden ser impuestos por el técnico o el

operador de la máquina mediante el fresado de ajuste de valor para obtener la calidad apropiada de la superficie mecanizada.

4. Si las condiciones son repetibles en la experiencia, los coeficientes de las ecuaciones de regresión son pertinentes y apropiados y pueden ser parte de la optimización paramétrica que es crucial en los estudios en el control de calidad así como en el diseño de la tecnología moderna y piezas de máquinas de nueva generación.



RZESZOW UNIVERSITY
OF TECHNOLOGY



WYDZIAŁ
BUDOWY MASZYN
I LOTNICTWA
POLITECHNIKI RZESZOWSKIEJ

Dipolma thesis

Author:

Miguel Carramiñana Elbaile

Theme of work:

SURFACE TEXTURE ANALYSIS AFTER BALL END MILLING

Supervisor: Sławomir Swirad

Type of study: bachelor studies

Course: Industrial engineering

Tasks to do:

1. Generation of a mathematical model
2. Application of the Hartley plan
3. Statistical analysis of results
4. Conclusions

I have received the theme:

*Date and signature
Of student*

*Date and signature of
supervisor*

*Date stamp and
signature of dept. manager*

*Date, stamp and
Sig. of a dean*

Index

Introduction.....	1
Theory	2
Planning and carrying out of the experiment:	27
Experiment data	34
Calculations and results	46
Results analysis and conclusions.....	64
Bibliography.....	68

Introduction

Surface roughness is a very important parameter that affects the quality of the component and tool life which indirectly affect the cost of manufacturing of the desired component.

In this research, the effect of three cutting parameters on surface roughness will be investigated during ball end milling on a steel X37CrMoV51. The three cutting parameter will be the following: depth of cut, width of cut and cutting speed.

Response surface methodology (RSM) will be used to develop a mathematical model for predicting the surface finish, for the different combinations of the cutting parameters mentioned before.

The test results obtained in an experiment carried out on the basis of this plan were subject to evaluation of repeatability conditions of experience implementation. It requires a comparison of the variance results. The variance of the results of one experiment deviating in terms of the value from the others may indicate atypical experience, such experience should be repeated. Cochran criterion was adopted as criterion for assessing the repeatability of experimental conditions, verifying the hypothesis of repeatability variance. The results of the research of process value, carried out on the basis of the adopted plan of experience allow to build a mathematical model of the object.

Theory

History of machining

The lathe, the origins of turning machines.

A lathe is a machine tool that rotates the workpiece on its axis to perform various operations such as cutting, sanding, knurling, drilling, shaping or deformation, facing, turning, with tools that are applied to the workpiece to create an object with axial symmetry along its axis of rotation.

Lathes (Fig. 1) are used in woodturning, metalworking, metal spinning, thermal spraying, parts reclamation, and glass-working. Lathes can be used to shape pottery, the best-known design being the potter's wheel.

Most suitably equipped metalworking lathes can also be used to produce most solids of revolution, plane surfaces and screw threads or helices. Ornamental lathes can produce three-dimensional solids of incredible complexity. The workpiece is usually held in place by either one or two points, at least one of which can typically be moved horizontally to accommodate varying workpiece lengths. Other work-holding methods include clamping the work about the axis of rotation using a chuck or collet, or to a faceplate, using clamps.

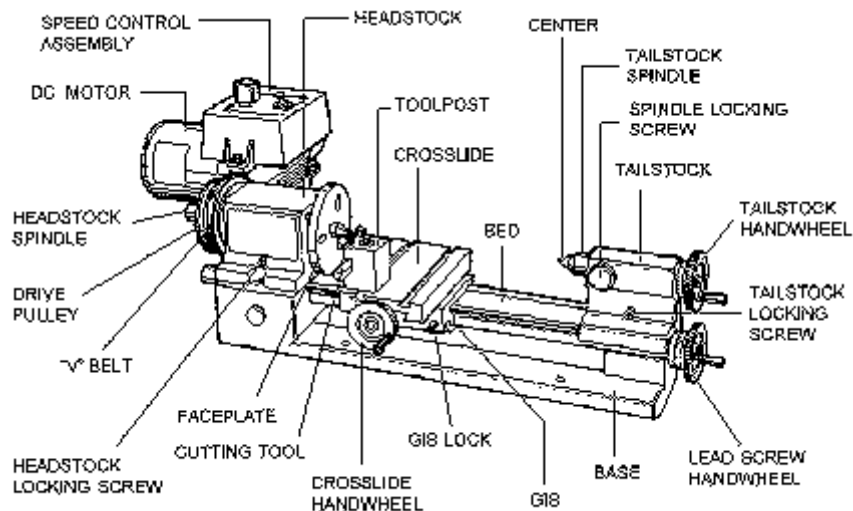

Fig 1 – Lathe machine

For the lathe machine to function and perform its operations, various important parts are integrated together. These essential parts make up the lathe machine and include the following:

-Stand (or legs). This is used in holding the lathe machine and in elevating the lathe bed to a working height.

-Bed. This is usually a horizontal beam that holds the chips and the swarfs.

-Headstock. The headstock contains the high precision bearings which hold the horizontal axle, more commonly known as the spindle.

-Spindle. This is a hollow horizontal axle with interior and exterior threads on the inboard by which the woodworking pieces can be mounted on.

-Tailstock. This is the counterpart of the headstock which contains a non-rotating barrel that can slide in and out directly in line with headstock spindle parallel to the axis of the bed.

-Carriage. This is composed of a saddle and an apron and is used as a mount to the cross-slide.

-Cross-slide. This is a flat piece that sits crosswise on the bed which can be cranked at right angles with the bed.

-Tool Post. Sits on top of the cross-slide and holds the cutting tool in place.

-Tool Rest. A horizontal area in line with the spindle and the tailstock from which hand tools are braced against and levered into the workpieces.

The lathe was a tool created a long time ago (though it is still used), known to have been used at least in the ancient Egypt and also in Assyria and ancient Greece. The lathe was also a key machine for the development of the Industrial Revolution.

The origin of turning dates to around 1300 B.C. when the Ancient Egyptians first developed a two-person lathe. One person would turn the wood work piece with a rope while the other used a sharp tool to cut shapes in the wood. Ancient Rome improved the Egyptian design with the addition of a turning bow. In the Middle Ages a pedal replaced hand-operated turning, allowing a single person to rotate the piece while working with both hands. The pedal was most of the times connected to a pole, often a straight-grained sapling. Today this system is known as the "spring pole" lathe.

An important early lathe in the UK was the horizontal boring machine. It was horse-powered and allowed the production of stronger and much more accurate cannons.



Fig 2 – Verbruggen workshop

One of the key characteristics of this machine was that the workpiece was turning as opposed to the tool, making it technically a lathe. Henry Maudslay who later developed many improvements to the lathe worked at the Royal Arsenal from 1783 being exposed to this machine in the Verbruggen workshop. (Fig. 2)

During the Industrial Revolution, mechanized power generated by water wheels or steam engines was transmitted to the lathe via line shafting, allowing faster and easier work. Metalworking lathes evolved into heavier versions with thicker and more rigid parts. Between the late 19th and mid-20th centuries, individual electric motors at each lathe replaced line shafting as the power source. Beginning in the 1950s, servomechanisms were applied to the control of lathes and other machine tools via numerical control, which often was coupled with computers to yield computerized numerical control (CNC). Today manually controlled and CNC lathes coexist in the manufacturing industries.

NC and CNC

The invention of numerical control has been due to the pioneering works of John T. Parsons in the year 1940, when he tried to generate a curve automatically by milling cutters by providing coordinate motions. In the late 1940s Parsons conceived the method of using punched cards containing coordinate position system to control a machine tool. The machine directed to move in small increments and generate the desired finish. In the year, 1948, Parons demonstrated this concept to the US Air Force, who sponsored the series of project at laboratories of Massachusetts Institute of Technology (MIT). After lots of research MIT was able to demonstrate first NC prototype in the year 1952 (Fig.3) and in the next year they were able to prove the potential applications of the NC.

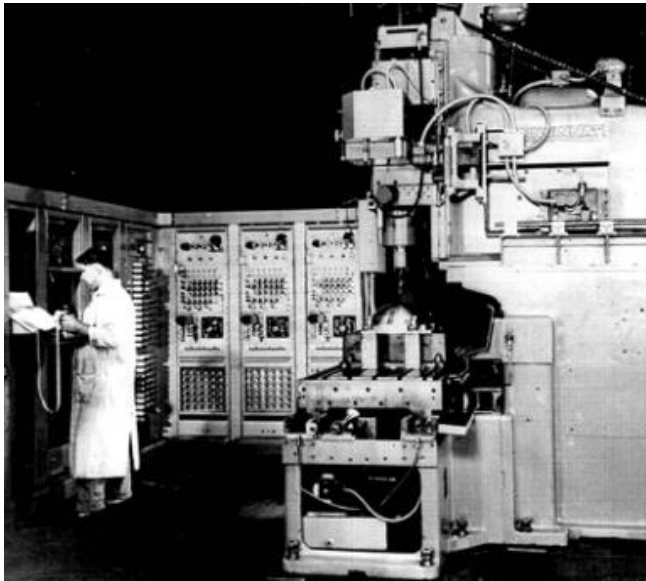

Fig 3 – NC prototype

This experimental machine was a turning point in the history of CNC milling, and there were many modifications made to the very first 28 inch vertical spindle contour milling machine. Three variable speeds would be added as well as hydraulic transmissions, and a feedback system would then be added. The true prototype for CNC would also be developed at Massachusetts in 1953, this machine using a tape reader, eight column papers, a Flexowriter, and a vacuum-tube electronic control

system.

Soon the machine tool manufacturers began their own efforts to introduce commercial NC units in the market. Meanwhile, the research continued as MIT, who were able to discover Automatically Programmed Tools, known as APT language that could be used for programming the NC machines. The main aim of APT language was to provide the means to the programmer by which they can communicate the machining instructions to the machine tools in easier manner using English like statements. The APT language is still used in widely in the manufacturing industry and a number of modern programming languages are based on the concepts of APT.

These rudimentary machines that were developed by Parsons share much in common with the most modern of CNC machines, modern machines being driven by anything as simple as a simple cam follower or anything as complex as a fully digital interface. The motion system of a modern machine can involve a cylinder, brake, valve, clutch, hydraulic motor, or a combination of any of these. The feedback system has now been replaced however with digital encoders that provide far more advanced technology.

A CNC lathe machine can take a piece of material and perform a variety of functions, including drilling and grinding. They can be used in the wood, metal and glass. Although they are generally relatively small, there are large industrial machinery lathe, it can handle a greater workload. It can also perform a wide variety of additional features. They are universal sets, computer numerically controlled (CNC) technology, can now control operations from a computer, rather than the cumbersome manual. This makes them easier to arrange and operate, and continuously stir with occasional supervision.

Using a computer to control the design and specifications of the lathe apparatus can be adjusted more accurately and the system and apparatus, it is necessary to using a lathe and operator does not necessarily have to be highly skilled or experienced with manual controls. Is seen as essential to the knowledge of personal computers in the past, and CNC technology refers to the general knowledgebase, general can learn how to operate in almost any type of machine. In the health and safety aspects of good news, because of these reasons, you need to use a multi-machine lathe. CNC lathe technology innovation, not only indicates that the new industrial machinery, but can bring the latest on older machines a good example.

CNC technology is a good choice, and manufacturers have a small budget, but high aspirations and work quality. Update the old machine to the new software can become faster, more reliable, and ultimately more profitable. It is easy to see why this type of technology has been proved in the manufacturing sector. This practice is known as computer-aided manufacturing (CAM). A description of the computer CAD module to provide manual control of the electronic control of the machine, which means that operators do not have to spend time to learn the inside out. This is a useful tool, production management, because it enables them to more effectively monitor and forecast production. CNC lathe is perfect integer multiples of the same item, and can perform a series of functions. Complex design can be more easily set using a CNC lathe technology; operators can expect to see a great accuracy. Manufacturers are looking for the best of the old technology; digital technology is a great way to reduce manufacturing costs, while maintaining good production speed and quality.

General information about metal cutting and machines

1. Metal cutting

Metal cutting or traditional machining processes are also known as conventional machining processes. These processes are commonly carried out in machine shops or tool room for machining a cylindrical or flat jobs to a desired shape, size and finish on a rough block of job material with the help of a wedge shaped tool. The cutting tool is constrained to move relative to the job in such a way that a layer of metal is removed in the form of a chip.

A machine tool is a power driven metal cutting machine which assist in managing the needed relative motion between cutting tool and the job that changes the size and shape of the job material. In the metal cutting process, working motion is imparted to the workpiece and cutting tool by the mechanisms of machine tool (Fig.4) so that the work and tool travel relative to each other and machine the workpiece material in the form of shavings known as chips. The machine tools involve various kinds of machines tools commonly named as lathe, shaper, planer, slotter, drilling, milling and grinding machines etc. Cylindrical jobs are generally machined using lathe, milling, drilling and cylindrical grinding whereas prismatic jobs are machined using shaper, planner, milling, drilling and surface grinding.

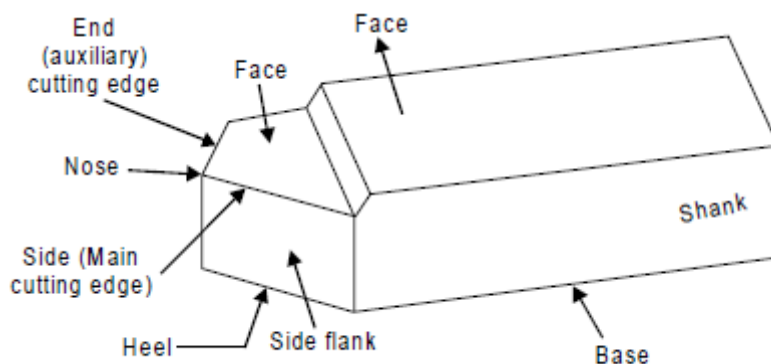

Fig 4 - Tool

In metal cutting operation, the position of cutting edge of the cutting tool is important based on which the cutting operation is classified as orthogonal cutting and oblique cutting. Cutting tools perform the main machining operation. They comprise of single point cutting tool or multipoint cutting tools. It is a body having teeth or cutting edges on it.

Mechanics of metal cutting

The work piece is securely clamped in a machine tool vice or clamps or chuck or collet. A wedge shape tool is set to a certain depth of cut and is forced to move in direction as shown in figure. All traditional machining processes require a cutting tool having a basic wedge shape at the cutting edge. The tool will cut or shear off the metal, provided the tool is harder than the metal, the tool is properly shaped so that its edge can be effective in cutting the metal, the tool is strong enough to resist cutting pressures but keen enough to sever the metal, and provided there is movement of tool relative to the material or vice versa, so as to make cutting action possible. Most metal cutting is done by high speed steel tools or carbide tools. In metal cutting, the metal is forced off the workpiece by being compressed, shearing off, and sliding along the face of the cutting tool.

All metals in the solid state have a characteristic crystalline structure, frequently referred to as grain structure. The grain or crystals vary in size from very fine to very coarse, depending upon the type of metal and its heat-treatment. The cutting tool advances again in the work piece. Heavy forces are exerted on the crystals in front of the tool face. These crystals, in turn exert similar pressures on crystals ahead of them, in the direction of the cut or force applied by the cutter.

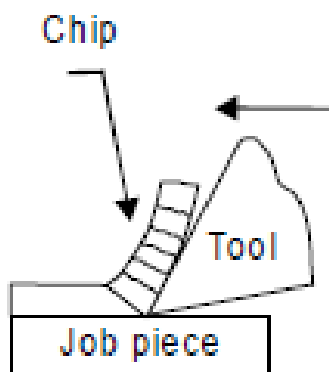

As the tool continues to advance, the material at sheared point is sheared by the cutting edge of the tool as shown in Fig 5 or it may be torn loose by the action of the bending chip which is being formed. As the tool advances, maximum stress is exerted along sheared line, which is called the shear plane. This plane is approximately perpendicular to the cutting face of the tool. There exists a shear zone on both sides of the shear plane, when the force of the tool exceeds the strength of the material at the shear plane, rupture

or slippage of the crystalline grain structure occurs, thus forming the metal chip.

Fig 5 – Cutting process

The chip gets separated from the workpiece material and moves up along the tool face. In addition, when the metal is sheared, the crystals are elongated, the direction of elongation being different from that of shear. The circles which represent the crystals in the uncut metal get elongated into ellipses after leaving the shearing plane.

Types of chips

Chips are separated from the workpiece to impart the required size and shape to the workpiece. The type of chips edge formed is basically a function of the work material and cutting conditions. The chips that are formed during metal cutting operations can be classified into four types:

1. Discontinuous or segmental chips (Fig 6 b): the chip is produced in the form of small pieces. These types of chips are obtained while machining brittle material like cast iron, brass and bronze. Fairly good surface finish is obtained and tool life is increased with this type of chips.

2. Continuous chips (Fig 6 a): These types of chips are obtained while machining ductile material such as mild steel and copper. A continuous chip comes from the cutting edge of a cutting tool as a single one piece, and it will remain as one piece unless purposely broken for safety or for convenience in handling. Formation of very lengthy chip is hazardous to the machining process and the machine operators.

3. Continuous chips with built-up edge (fig 6 c): During cutting operation, the temperature rises and as the hot chip passes over the face of the tool, alloying and welding action may take place due to high pressure, which results in the formation of weak bonds in microstructure and weakened particles might pullout. Owing to high heat and pressure generated, these particles get welded to the cutting tip of the tool and form a false cutting edge.

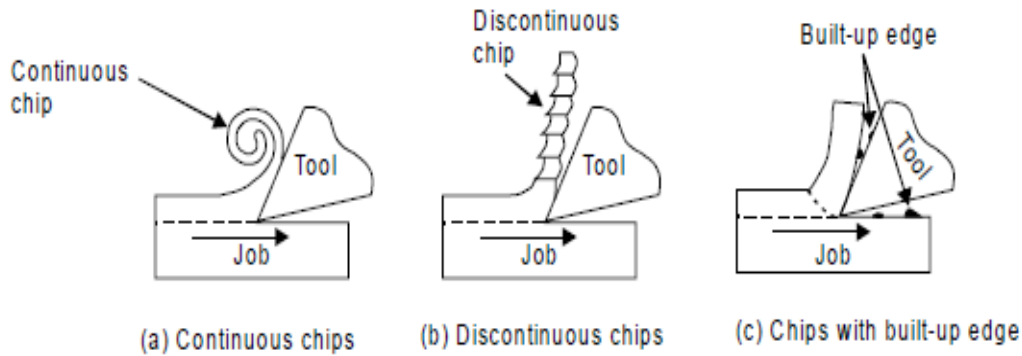

Fig 6 – Different types of chips

Coolents or cutting fluids

During any machining or metal cutting process, enough heat is evolved in cutting zone. To remove this heat from cutting zone, soluble oils are used as cutting fluid during machining.

Emulsions (also known as soluble oil) cool the work-piece and tool and thus relieved them from overheat. Air circulation is required so as to remove the heat by evaporation. The remaining oil forms a protecting layer over the machined work piece and save it from rust and corrosion. Such coolants decrease adhesion between chip and tool, provides lower friction and wear and a smaller built up edge. They remove chips and hence help in keeping freshly machined surface bright. They also protect the surface from corrosion. They decrease wear and tear of tool and hence increase tool life. They improve machinability and reduce machining forces.

2.The lathe machine

The lathe shown in Fig 7 is one of the most versatile and widely used machine tools all over the world. It is commonly known as the mother of all other machine tool. The main function of a lathe is to remove metal from a job to give it the required shape and size. The job is securely and rigidly held in the chuck or in between centers on the lathe machine and then turn it against a single point cutting tool which will remove metal from the job in the form of chips.

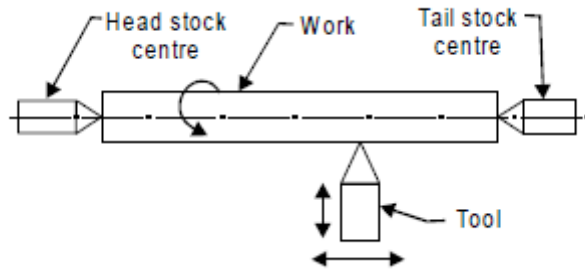

Fig 7 – Lathe machine scheme

Types of lathe: Lathes are manufactured in a variety of types and sizes, from very small bench lathes used for precision work to huge lathes used for turning large steel shafts. But the principle of operation and function of all types of lathes is same.

The different types of lathes are:

- Speed lathe: It has no feed box, leadscrew or conventional type of carriage. The tool is mounted on the adjustable slide and is fed into the work by hand control. The speed lathe finds applications where cutting force is least such as in wood working, spinning, centering, polishing, winding, buffing etc.
- Center lathe: Similar to the speed lathe, the engine lathe has all the basic parts, e.g., bed, headstock, and tailstock. But its headstock is much more robust in construction and contains additional mechanism for driving the lathe spindle at multiple speeds. Unlike the speed lathe, the engine lathe can feed the cutting tool both in cross and longitudinal direction with reference to the lathe axis with the help of a carriage, feed rod and lead screw.
- Bench lathe: This is a small lathe usually mounted on a bench. It has practically all the parts of an engine lathe or speed lathe and it performs almost all the operations. This is used for small and precision work.
- Tool room lathe: This lathe has features similar to an engine lathe but it is much more accurately built. It has a wide range of spindle speeds ranging from a very low to a quite high speed up to 2500 rpm. This lathe is mainly used for precision work on tools, dies, gauges and in machining work where accuracy is needed.

- Capstan and turret lathe: The distinguishing feature of this type of lathe is that the tailstock of an engine lathe is replaced by a hexagonal turret, on the face of which multiple tools may be fitted and fed into the work in proper sequence. Due to this arrangement, several different types of operations can be done on a job without re-setting of work or tools.
- Automatic lathes: These lathes are so designed that all the working and job handling movements of the complete manufacturing process for a job are done automatically. These are high speed, heavy duty, mass production lathes with complete automatic control.

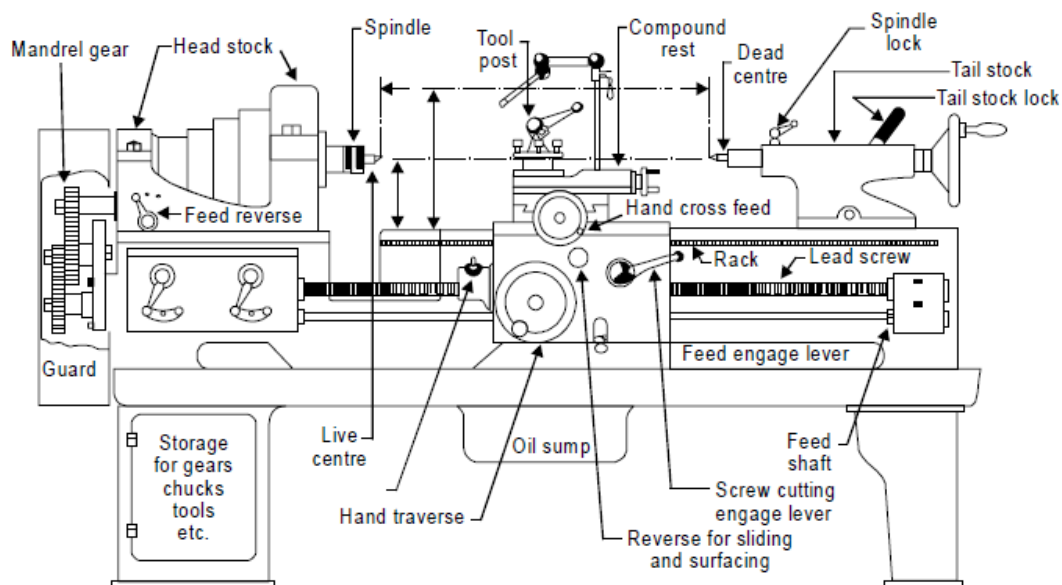

Fig 8 – Parts of lathe machine

Accessories and attachments of the lathe

- Lathe centers: They are made of very hard materials to resist deflection and wear and they are used to hold and support the cylindrical Jobs.
- Carriers: These are used to drive a job when it is held between two centers. Carriers or driving dogs are attached to the end of the job by a setscrew. Catch plates are either screwed or bolted to the nose of the headstock spindle. A projecting pin from the catch plate or carrier fits into the slot provided in either of them. This imparts a positive drive between the lathe spindle and job.

- Chucks: It is basically attached to the headstock spindle of the lathe. The internal threads in the chuck fit on to the external threads on the spindle nose. Jobs of short length and large diameter or of irregular shape, which cannot be conveniently mounted between centers, are held quickly and rigidly in a chuck.
- Face plates: Face plates are employed for holding jobs, which cannot be conveniently held between centers or by chucks. A face plate possesses the radial, plain and T slots for holding jobs or work-pieces by bolts and clamps. Face plates consist of a circular disc bored out and threaded to fit the nose of the lathe spindle.
-
- Angle plates: Angle plate is a cast iron plate having two faces machined to make them absolutely at right angles to each other. Holes and slots are provided on both faces so that it may be clamped on a faceplate and can hold the job or workpiece on the other face by bolts and clamps. The plates are used in conjunction with a face plate when the holding surface of the job should be kept horizontal.
-
- Mandrels: A mandrel is a device used for holding and rotating a hollow job that has been previously drilled or bored. The job revolves with the mandrel, which is mounted between two centers. It is rotated by the lathe dog and the catch plate and it drives the work by friction. Different types of mandrels are employed according to specific requirements. It is hardened and tempered steel shaft or bar with 60° centers, so that it can be mounted between centers. It holds and locates a part from its center hole. The mandrel is always rotated with the help of a lathe dog; it is never placed in a chuck for turning the job. A mandrel unlike an arbor is a job holding device rather than a cutting tool holder. A bush can be faced and turned by holding the same on a mandrel between centers. It is generally used in order to machine the entire length of a hollow job.
- Rests: A rest is a lathe device, which supports a long slender job, when it is turned between centers or by a chuck, at some intermediate point to prevent bending of the job due to its own weight and vibration set up due to the cutting force that acts on it. The two types of rests commonly used for supporting a long job in an engine lathe are the steady or centre rest and the follower rest.

Lathe operations

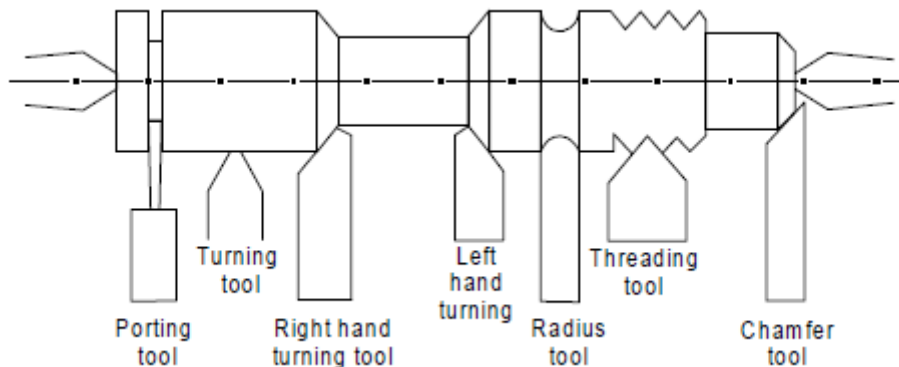

Fig 9 – Different tools for operations

For performing the various machining operations in a lathe, the job is being supported and driven by any one of the following methods:

Operations shown in Fig 9 can be performed in a lathe either by holding the workpiece between centers or by a chuck are: straight turning, taper turning, eccentric turning, facing, filing, grooving, spinning, shoulder turning, chamfering, thread cutting, forming, polishing, knurling, spring winding.

Operations which are performed by holding the work by a chuck or a faceplate or an angle plate are: undercutting, internal thread cutting, reaming, counter boring, tapping, parting-off, drilling, boring, taper boring.

Operations which are performed by using special lathe attachments are: Facing workpiece on centers, straight turning, shouldering, filleting, radius turning, necking, taper turning, external thread cutting, forming.

Taper turning: A taper is defined as a uniform increase or decrease in diameter of a piece of work measured along its length. In a lathe machine, taper turning means to produce a conical surface by gradual reduction in diameter from a cylindrical job. Taper in the British System is expressed in taper per foot or taper per inch.

A taper is generally turned in a lathe by feeding the tool at an angle to the axis of rotation of the workpiece. The angle formed by the path of the tool with the axis of the workpiece should correspond to the half taper angle.

Thread cutting

Thread of any pitch, shape and size can be cut on a lathe using single point cutting tool as shown in Fig 10. Thread cutting is operation of producing a helical groove on spindle shape such as V, square or power threads on a cylindrical surface. The job is held in between centres or in a chuck and the cutting tool is held on tool post. The cutting tool must travel a distance equal to the pitch (in mm) as the work piece completes a revolution. The definite relative rotary and linear motion between job and cutting tool is achieved by locking or engaging a carriage motion with lead screw and nut mechanism and fixing a gear ratio between head stock spindle and lead screw. To make or cut threads, the cutting tool is brought to the start of job and a small depth of cut is given to cutting tool using cross slide.

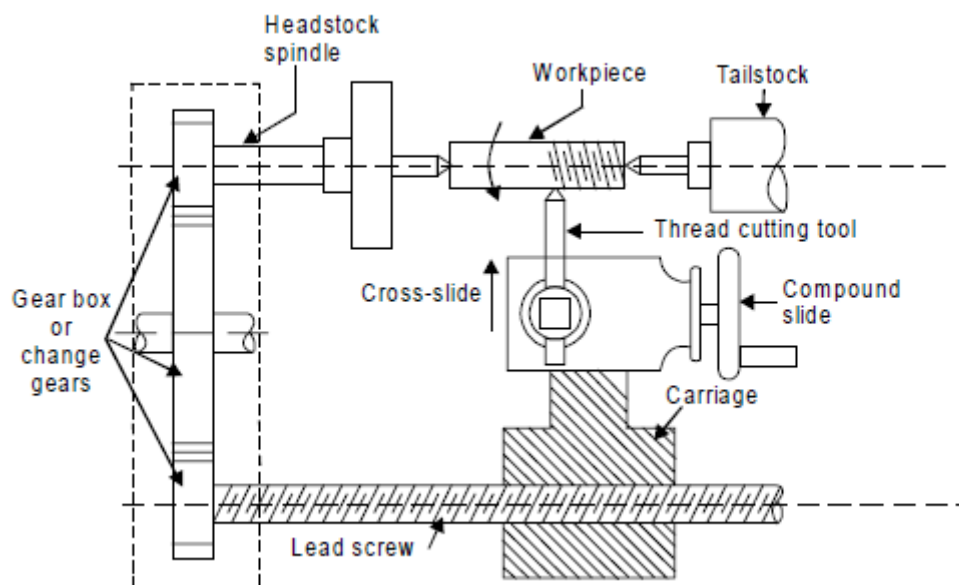

Fig 10 – Thread cutting

Drilling on a lathe

For producing holes in jobs on lathe, the job is held in a chuck or on a face plate. The drill is held in the position of tailstock and which is brought nearer the job by moving the tailstock along the guide ways, the thus drill is fed against the rotating job.

Important cutting parameters:

Cutting speed: Cutting speed for lathe work may be defined as the rate in meters per minute at which the surface of the job moves past the cutting tool. Machining at a correct cutting speed is highly important for good tool life and efficient cutting. Too slow cutting speeds reduce productivity and increase manufacturing costs whereas too high cutting speeds result in overheating of the tool and premature failure of the cutting edge of the tool.

Feed: Feed is defined as the distance that a tool advances into the work during one revolution of the headstock spindle. It is usually given as a linear movement per revolution of the spindle or job. During turning a job on the center lathe, the saddle and the tool post move along the bed of the lathe for a particular feed for cutting along the length of the rotating job.

3. Drilling machine

Drilling is an operation of making a circular hole by removing a volume of metal from the job by cutting tool called drill. A drill is a rotary end-cutting tool with one or more cutting lips and usually one or more flutes for the passage of chips and the admission of cutting fluid. A drilling machine (Fig 11) is a machine tool designed for drilling holes in metals. It is one of the most important and versatile machine tools in a workshop. Besides drilling round holes, many other operations can also be performed on the drilling machine such as counter- boring, countersinking, honing, reaming, lapping, sanding etc.

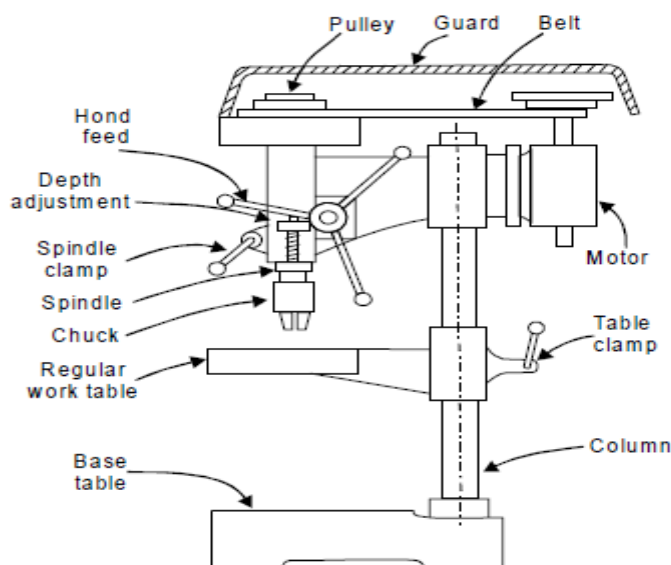

Fig 11 – Parts of a drilling machine

Types of drills

A drill is a multi point cutting tool used to produce or enlarge a hole in the workpiece. It usually consists of two cutting edges set an angle with the axis. Broadly there are three types of drills:

1. Flat drill
2. Straight-fluted drill
3. Twist drill

Flat drill is usually made from a piece of round steel which is forged to shape and ground to size, then hardened and tempered. The cutting angle is usually 90 deg. and the relief or clearance at the cutting edge is 3 to 8 deg. The disadvantage of this type of drill is that each time the drill is ground the diameter is reduced. Twist drill is the most common type of drill in use today.

In metric system, the drill is generally manufactured from 0.2 to 100 mm. In British system the drills sizes range from No. 1 to No. 80. Number 80 is the smallest having diameter equal to 0.0135 inch and the number 1 is the largest having diameter equal to 0.228 inch.

Number 1 to number 60 is the standard sets of drills. The numbers 61 to 80 sizes drills are not so commonly used. The diameter of drills increases in steps of approximately by 0.002 inch.

Drills are made are made up of high speed steel. High speed steel is used for about 90 per cent of all twist drills. For metals more difficult to cut, HSS alloys of high cobalt series are used.

Operations:

Drilling (Fig 12): This is the operation of making a circular hole by

removing a volume of metal from the job by a rotating cutting tool called drill. Drilling removes solid metal from the job to produce a circular hole. Before drilling, the hole is located by drawing two lines at right angle and a center punch is used to make an indentation for the drill point at the center to help the drill in getting started. A suitable drill is held in the drill

machine and the drill machine is adjusted to operate at the correct cutting speed. The drill machine is started and the drill starts rotating. Cutting fluid is made to flow liberally and the cut is started. The rotating drill is made to feed into the job. The hole, depending upon its length, may be drilled in one or more steps. After the drilling operation is complete, the drill is removed from the hole and the power is turned off.

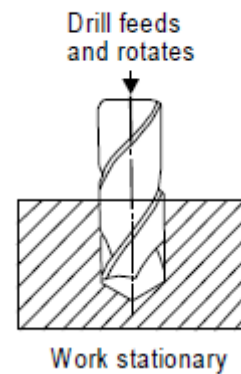

Fig 12 -Normal drilling

Reaming (Fig 13):

This is the operation of sizing and finishing a hole already made by a drill. Reaming is performed by means of a cutting tool called.

Reaming operation serves to make the hole smooth, straight and accurate in diameter. Reaming operation is performed by means of a multitooth tool called reamer. Reamer possesses several cutting edges on outer periphery and may be classified as solid reamer and adjustable reamer.

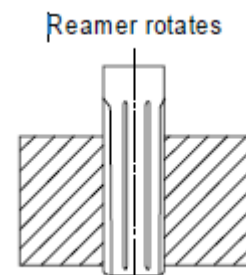

Fig 13 - Reaming

Counter-boring (Fig 14):

It is the operation of enlarging the end of a hole cylindrically, as for the recess for a counter-sunk rivet. The tool used is known as counter-bore.

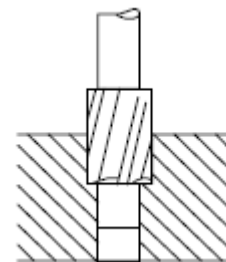

Fig 14 – Counter-boring

Counter-sinking (Fig 15):

This is the operation of making a coneshaped enlargement of the end of a hole, as for the recess for a flat head screw. This is done for providing a seat for counter sunk heads of the screws so that the latter may flush with the main surface of the work.

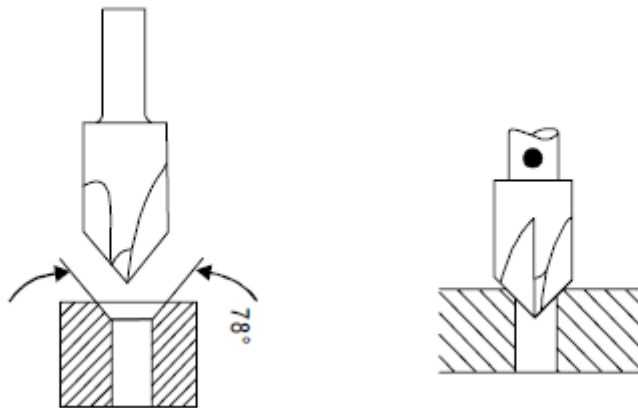

Fig 15 – Counter-sinking

Lapping

This is the operation of sizing and finishing a hole by removing very small amounts of material by means of an abrasive. The abrasive material is kept in contact with the sides of a hole that is to be lapped, by the use of a lapping tool.

4. Shaper, planer and slotter

Shaper

The shaper shown in Fig 16 is a reciprocating type of machine tool in which the ram moves the cutting tool backwards and forwards in a straight line. It is intended primarily to produce flat surfaces. These surfaces may be horizontal, vertical, or inclined. In general, the shaper can produce any surface composed of straight-line elements.

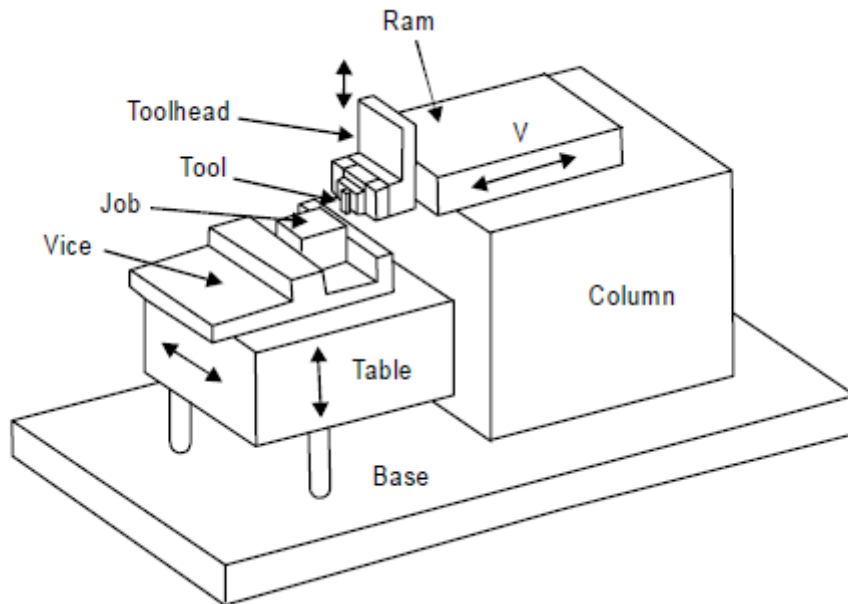

Fig 16 - Shaper

A single point cutting tool is held in the tool holder, which is mounted on the ram. The workpiece is rigidly held in a vice or clamped directly on the table. The table may be supported at the outer end. The ram reciprocates and thus cutting tool held in tool holder moves forward and backward over the workpiece. In a standard shaper, cutting of material takes place during the forward stroke of the ram. The backward stroke remains idle and no cutting takes place during this stroke. The feed is given to the workpiece and depth of cut is adjusted by moving the tool downward towards the workpiece. The time taken during the idle stroke is less as compared to forward cutting stroke and this is obtained by quick return mechanism.

Planer

Like a shaper, the planer shown in Fig 17 is used primarily to produce horizontal, vertical or inclined flat surfaces by a single point cutting tool. But it is used for machining large and heavy workpieces that cannot be accommodated on the table of a shaper. In addition to machining large work, the planer is frequently used to machine multiple small parts held in line on the platen. Planer is mainly of two kinds namely open housing planer and double housing planer.

The bigger job is fixed with help of the grooves on the base of the planer and is accurately guided as it travels back and forth. Cutting tools are held in tool heads of double housing planer and the work piece is clamped onto the worktable. The worktable rides on the gin tool heads that can travel from side to side i.e., in a

direction at right angle to the direction of motion of the worktable. Tool heads are mounted on a horizontal cross rail that can be moved up and down. Cutting is achieved by applying the linear primary motion to the workpiece (motion X) and feeding the tool at right angles to this motion (motion Y and Z). The primary motion of the worktable is normally accomplished by a rack and pinion drive using a variable speed motor. As with the shaper, the tool posts are mounted on clapper boxes to prevent interference between the tools and work-piece on the return stroke and the feed motion is intermittent.

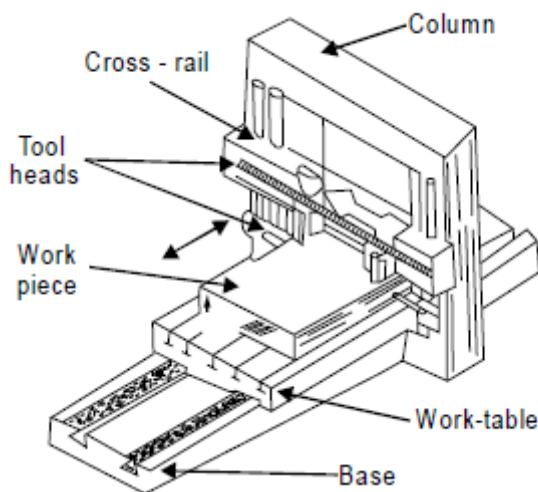

Fig 17 – Planer machine

Slotter

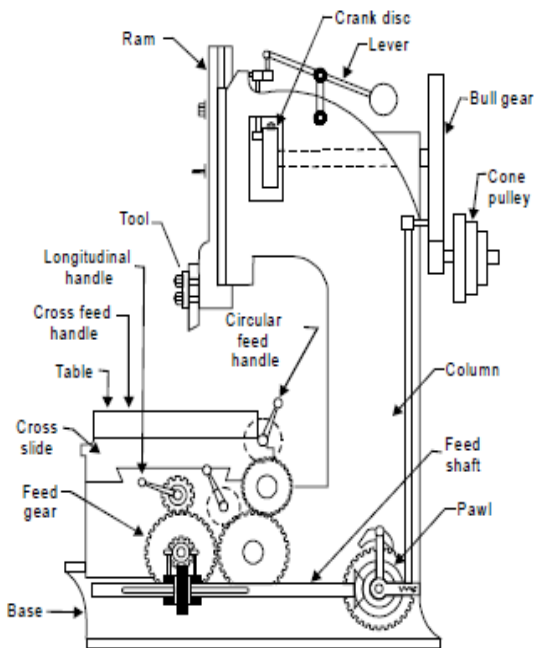

Fig 18 – Slotter machine

The slotter or slotting machine (Fig 18) is also a reciprocating type of machine tool similar to a shaper or a planer. It may be considered as a vertical shaper. The chief difference between a shaper and a slotter is the direction of the cutting action. The machine operates in a manner similar to the shaper, however, the tool moves vertically rather than in a horizontal direction. The job is held stationary. The slotter has a vertical ram and a hand or power operated rotary table.

5.Milling

A milling machine (Fig 21) is a machine tool that removes metal as the work is fed against a rotating multipoint cutter. The milling cutter rotates at high speed and it removes metal at a very fast rate with the help of multiple cutting edges. One or more number of cutters can be mounted simultaneously on the arbor of milling machine. This is the reason that a milling machine finds wide application in production work. Milling machine is used for machining flat surfaces, contoured surfaces, surfaces of revolution, external and internal threads, and helical surfaces of various cross-sections.

In milling machine, the metal is cut by means of a rotating cutter having multiple cutting edges. For cutting operation, the workpiece is fed against the rotary cutter. As the workpiece moves against the cutting edges of milling cutter, metal is removed in form chips of trochoid shape. Machined surface is formed in one or more passes of the work. The work to be machined is held in a vice, a rotary table, a three jaw chuck, an index head, between centers, in a special fixture or bolted to machine table. The rotatory speed of the cutting tool and the feed rate of the workpiece depend upon the type of material being machined.

Up milling

In the up-milling the metal is removed in form of small chips by a cutter rotating against the direction of travel of the workpiece as described in Fig 19. In this type of milling, the chip thickness is minimum at the start of the cut and maximum at the end of cut. As a result the cutting force also varies from zero to the maximum value per tooth movement of the milling cutter. The major disadvantages of up-milling process are the tendency of cutting force to lift the work from the fixtures and poor surface finish obtained.

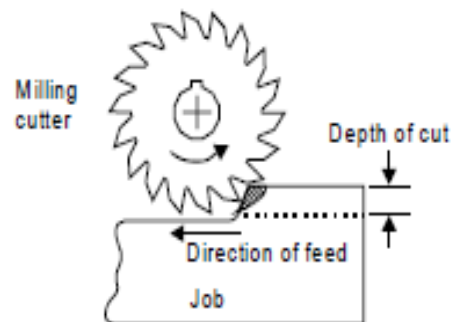

Fig 19 – Up milling

Down milling

In this method, the metal is removed by a cutter rotating in the same direction of feed of the workpiece as seen in Fig 20. The effect of this is that the teeth cut downward instead of upwards.

Chip thickness is maximum at the start of the cut and minimum in the end. In this method, it is claimed that there is less friction involved and consequently less heat is generated on the contact surface of the cutter and workpiece.

Climb milling can be used advantageously on many kinds of work to increase the number of pieces per sharpening and to produce a better finish. With climb milling, saws cut long thin slots more satisfactorily than with standard milling. Another advantage is that slightly lower power consumption is obtainable by climb milling, since there is no need to drive the table against the cutter.

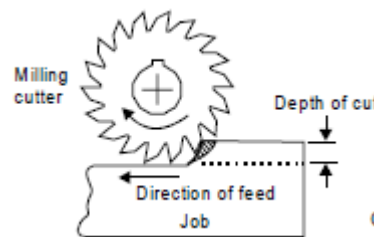

Fig 20 – Down milling

Types of milling machines

Milling machine rotates the cutter mounted on the arbor of the machine and at the same time automatically feed the work in the required direction. The milling machine may be classified in several forms, but the choice of any particular machine is determined primarily by the size of the workpiece to be undertaken and operations to be performed.

Column and knee type milling machine

The table is mounted on the knee casting which in turn is mounted on the vertical slides of the main column. The knee is vertically adjustable on the column so that the table can be moved up and down to accommodate work of various heights.

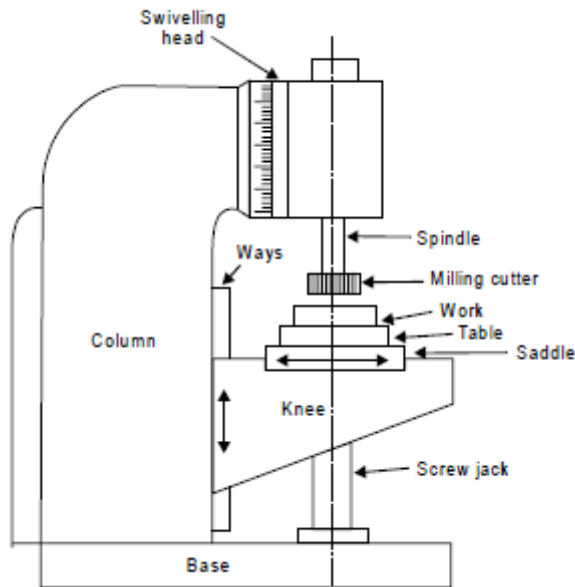

Fig 21 – Milling machine

Planer type milling machine

It is a heavy duty milling machine. It resembles a planer and like a planing machine it has a cross rail capable of being raised or lowered carrying the cutters, their heads, and the saddles, all supported by rigid uprights. There may be a number of independent spindles carrying cutters on the rail as two heads on the uprights. The use of the machine is limited to production work only and is considered ultimate in metal re-moving capacity.

Special type milling machine

Milling machines of non-conventional design have been developed to suit special purposes. The features that they have in common are the spindle for rotating the cutter and provision for moving the tool or the work in different directions.

Operations performed on the milling machine

- Plain milling: It is a method of producing a plain, flat, horizontal surface parallel to the axis of rotation of the cutter.
- Side milling: It is the operation of production of a flat vertical surface on the side of a work-piece by using a side milling cutter.

- Form milling: It is, a method of producing a surface having an irregular outline.

- Profile milling: It is the operation of reproduction of an outline of a template or complex shape of a master die on a workpiece.

- Saw milling: It is a method of producing deep slots and cutting materials into the required length by slitting saws.

- Thread milling : It is a method of milling threads on dies, screws, worms, etc. both internally and externally. As an alternative to the screw cutting in a lathe, this method is being more extensively introduced now a day in modern machine shops.

Planning and carrying out of the experiment:

1. Material, machines and mathematical method used in the experiment:

Milling machine: HASS VF -1 (Fig 22)

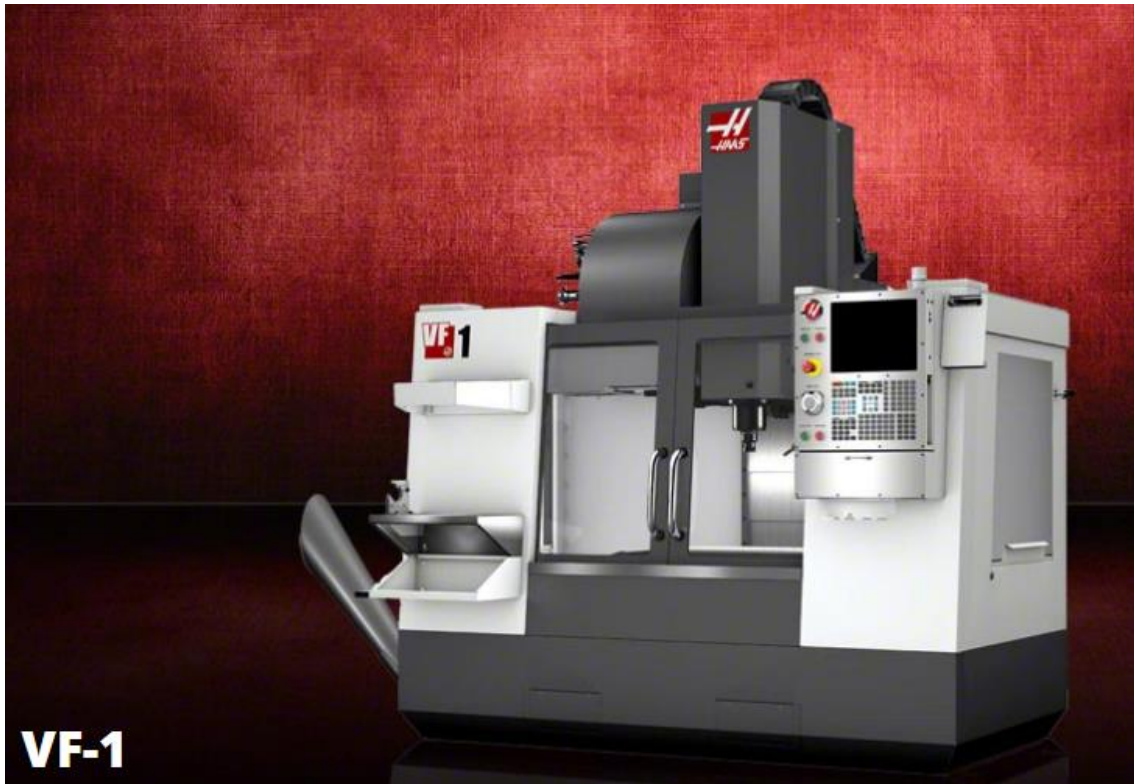

Fig 22 – Hass VF-1

Specifications of the milling machine:

Vertical Machining Center; 20" x 16" x 20" (508 x 406 x 508 mm), 40 taper, 30 hp (22.4 kW) vector drive, 8100 rpm, inline direct-drive, 20-station carousel tool changer, 1000 ipm (25.4 m/min) rapids, power-failure detection module, 1 GB program memory, 15" color LCD monitor, USB port, memory lock keyswitch, rigid tapping and 55-gallon (208 liter) flood coolant system.

SPINDLE	S.A.E.	METRIC
Max Rating	30 hp	22.4 kW
Max Speed	8100 rpm	8100 rpm
Max Torque	90 ft-lb @ 2000 rpm	122 Nm @ 2000 rpm
Drive System	Inline Direct-Drive	Inline Direct-Drive
Max Torque w/opt Gearbox	250 ft-lb @450 rpm	339 Nm @ 450 rpm
Taper	CT or BT 40	CT or BT 40
Bearing Lubrication	Air/Oil Injection	Air/Oil Injection
Cooling	Liquid Cooled	Liquid Cooled

Table 1 – Specifications of the machine Hass VF-1

Steel X37CrMoV51:

The X38CrMoV51 steel was used as the sample material. It is a chromium-molybdenum alloy steel for hot work. Steel is used for elements of molds for pressure die casting, extrusion tools for low-melting alloys, die inserts, dies, punches, etc.. It is also used in the loaded parts of the press for the extrusion of tubes and rods. It is required that the steel retains its properties to 600 ° C. This is achieved by the use of tungsten and molybdenum, as alloying additions.

This steel has very good mechanical properties, such as high tensile strength and hardness (HRC 54 to 100 ° C), high yield strength (up to 2200 MPa), high abrasion resistance and high density (7.85 g / cm³). The chemical composition of the Steel is shown in Table 1:

Chemical composition of the sample.

Chemical composition [%]						
C	Mn	Si	P	S	Cr	Mo
0,42	0,5	1,2	0,03	0,03	5,5	1,5

Table 2 – Chemical composition of the Steel X37CrMoV51

Talysurf CCI - Lite Non-contact 3D Profiler (Fig 23):

This is the equipment used in the experiment to measure all the parameters of the machined surface.

The Talysurf CCI Lite is an advanced type of measurement interferometer. It uses an innovative, patented correlation algorithm to find the coherence peak and phase position of an interference pattern produced by a precision optical scanning unit.



Fig 23.

The Talysurf CCI Lite is invaluable for many applications requiring high precision 3D profile analysis. A variety of objectives are available and can be fitted simultaneously to the turret enabling many types of surface to be measured. A fully automated stage and auto measurement routines add to the high level of flexibility of the system.

Talysurf CCI Lite System Specifications	
Measurement technique	Coherence Correlation Interferometry
Vertical range [Z]	2.2 mm as standard (>10 mm with Z-stitching)
Vertical resolution [max]	0.01 nm [0.1 Å]
Noise floor [Z]	<0.08 nm [0.8 Å] ¹
Repeatability of surface RMS [Z]	<0.02 nm [0.2 Å] ²
Max. Measurement area [X, Y]	6.6 mm (>75 mm with X, Y stitching)
Number of measurement points	1024 x 1024 standard
Optical resolution [X, Y]	0.4 - 0.6µm (surface dependent)
Step height repeatability	<0.1%
Surface reflectivity	0.3% - 100%
Measurement time	5-40 seconds (typical)

Table 3 – Specifications of Talysurf CCI

Mathematical model:

The mathematical models used in the experiment will be a full factorial design with 3 factors and 3 levels, 3^3 .

In statistics, a full factorial experiment is an experiment whose design consists of two or more factors, each with discrete possible values or "levels".

A full factorial design contains all possible combinations of a set of factors. This is the most fool proof design approach, but it is also the most costly in experimental resources. The full factorial designer supports both continuous factors and categorical factors with up to nine levels.

In full factorial designs, you perform an experimental run at every combination of the factor levels. The sample size is the product of the numbers of levels of the factors.

Full factorial designs are the most conservative of all design types. There is little scope for ambiguity when you are willing to try all combinations of the factor settings.

A factorial experiment allows for estimation of experimental error in two ways. The experiment can be replicated, or the sparsity-of-effects principle can often be exploited. Replication is more common for small experiments and is a very reliable way of assessing experimental error. When the number of factors is

large (typically more than about 5 factors, but this does vary by application), replication of the design can become operationally difficult. In these cases, it is common to only run a single replicate of the design, and to assume that factor interactions of more than a certain order (say, between three or more factors) are negligible. Under this assumption, estimates of such high order interactions are estimates of an exact zero, thus really an estimate of experimental error.

A factorial experiment can be analyzed using ANOVA or regression analysis. In our case we used the regression analysis.

For the mathematical analysis the following steps were followed:

- calculation of the regression coefficients,
- calculation of the variance measurement errors $S^2(y)$,
- assessment of the reproducibility of the experimental conditions by criterion of Cochran,
- calculation of the regression coefficients,
- assessment of the significance of the coefficients of the regression equation.
- rejection of negligible coefficients and decoding the regression equations

2. The experiment.

The Design of experiments was done using full factorial, statically (3^n) design (Hartley design). The parameters taken into consideration in this experiment were: depth of cut (a_p), width of cut (a) and cutting speed (v). Each of them with three levels (three different values).

Other parameters were held constant. If it hadn't been like that the experiment would have had to have a lot more values and would have been very complex.

Here are the values of the three parameters and the full factorial design of them exposed in Table 2 and Table 3 respectively.

Table of the parameters and their values:

VALUE	x ₁ Depth of the cut P [mm]	x ₂ Speed V [mm/min]	x ₃ Width a [mm]
+	0,3	1500	0,1
0	0,2	1000	0,075
-	0,1	500	0,05

Table 4

Table 5 showing the full factorial design:

Expt. No.	Coded values			Actual values		
	x ₁	x ₂	x ₃	x ₁ Depth of the cut aP [MPa]	x ₂ Speed V [mm/min]	x ₃ Width a [mm]
1	+	+	+	0,3	1500	0,1
2	+	-	-	0,3	500	0,05
3	-	+	-	0,1	1000	0,05
4	-	-	+	0,1	500	0,1
5	+	0	0	0,3	1000	0,075
6	-	0	0	0,1	1000	0,075
7	0	+	0	0,2	1500	0,075
8	0	-	0	0,2	500	0,075
9	0	0	+	0,2	1000	0,1
10	0	0	-	0,2	1000	0,05
11	0	0	0	0,2	1000	0,075

Table 5 – Full factorial design

The parameters used to describe the surface texture were the following:

- S_q - root mean square height of the surface,
- S_{sk} - skewness of height distribution,
- S_{ku} - kurtosis of height distribution,
- S_p - maximum height of peaks,
- S_v - maximum height of valleys,
- S_z - maximum height of the surface,
- S_a - arithmetical mean height of the surface.

Finally the data obtained was analyzed.

The experiment data and results will be exposed in their respective sections.

Experiment data

Fig 24 **Experiment No. 1** ($a_p = 0,3\text{mm}$, $V = 1500\text{mm/min}$, $a = 0,1\text{mm}$)

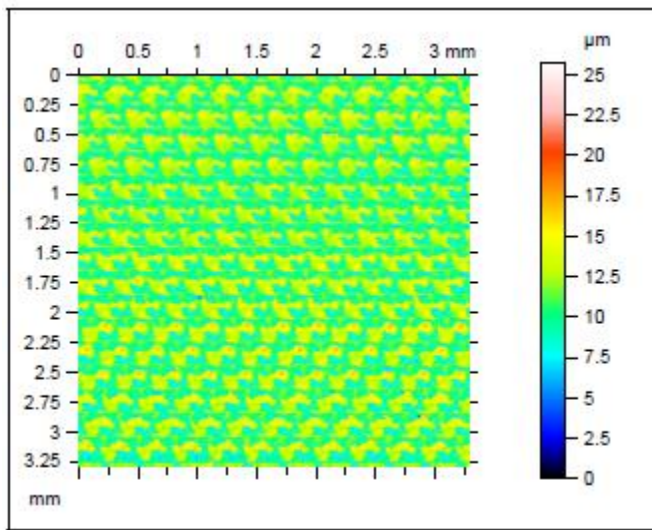

Parametry wysokości		
Sq	2.16	μm
Ssk	0.0281	
Sku	2.24	
Sp	14.4	μm
Sv	11.3	μm
Sz	25.7	μm
Sa	1.82	μm

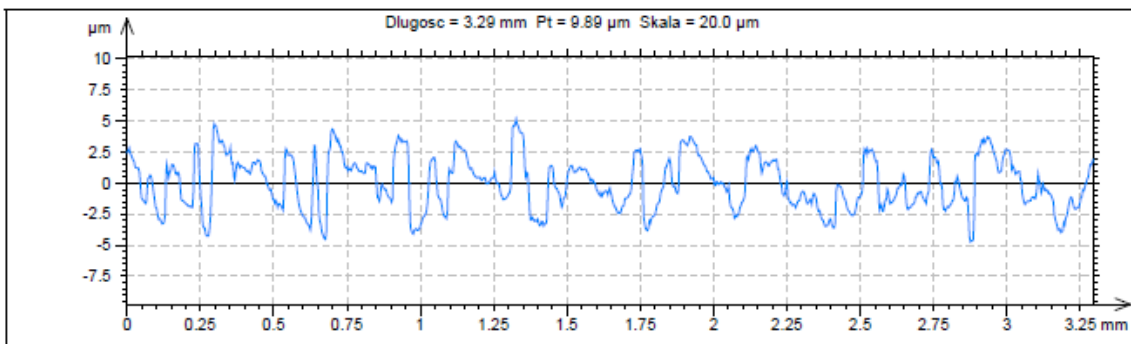
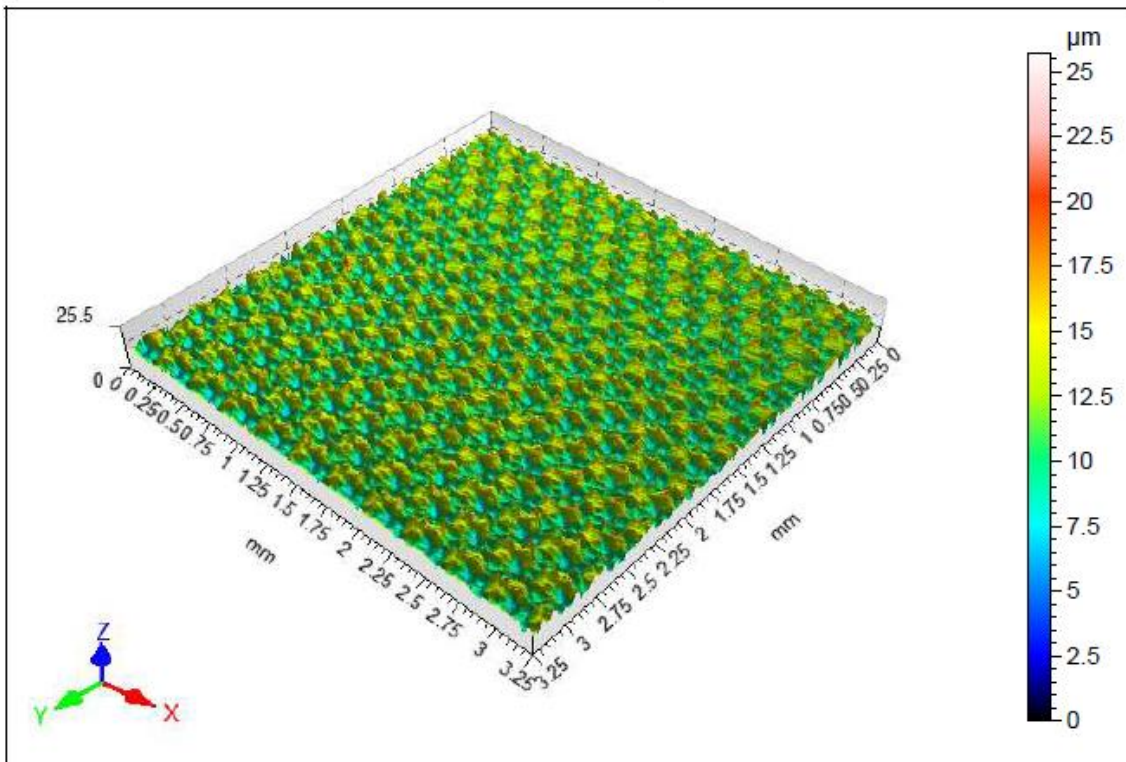
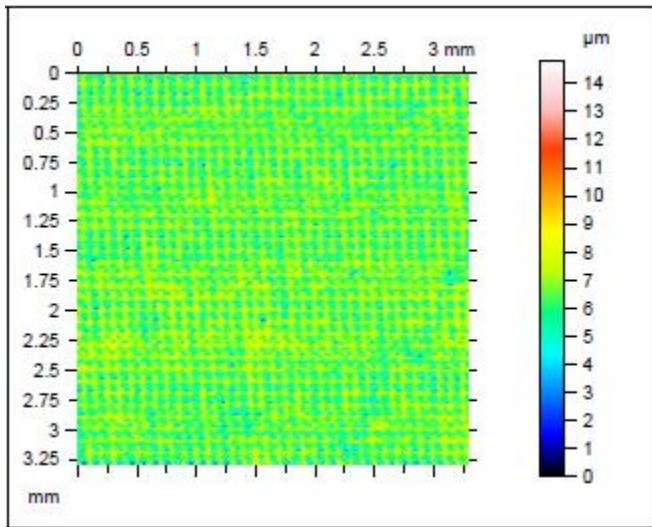

Fig 25

Experiment No. 2 ($a_p = 0,3\text{mm}$, $V = 500\text{mm/min}$, $a = 0,05\text{mm}$)



Parametry wysokości		
Sq	0.921	µm
Ssk	-0.734	
Sku	3.90	
Sp	8.31	µm
Sv	6.47	µm
Sz	14.8	µm
Sa	0.727	µm

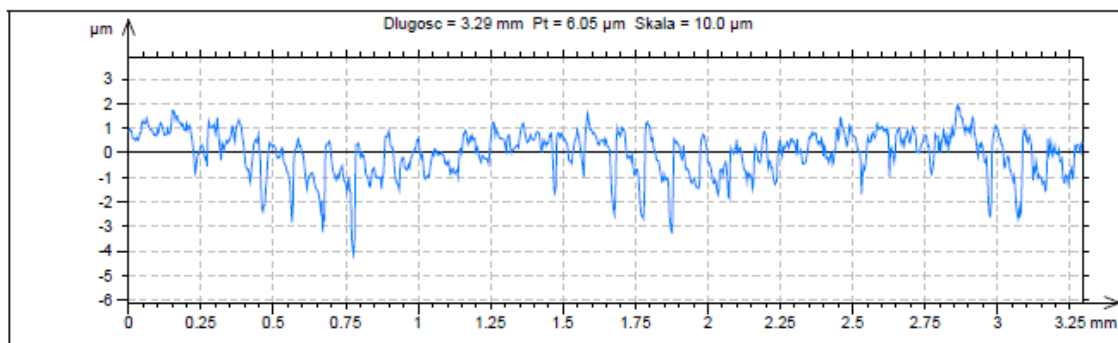
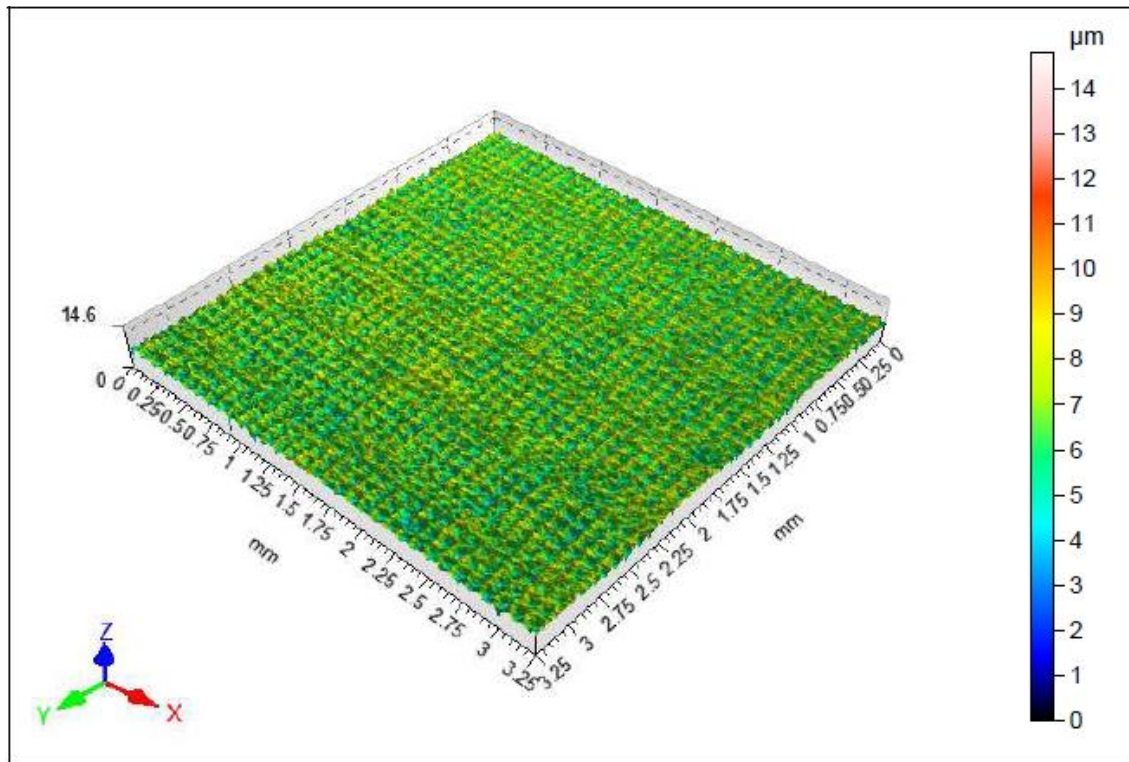
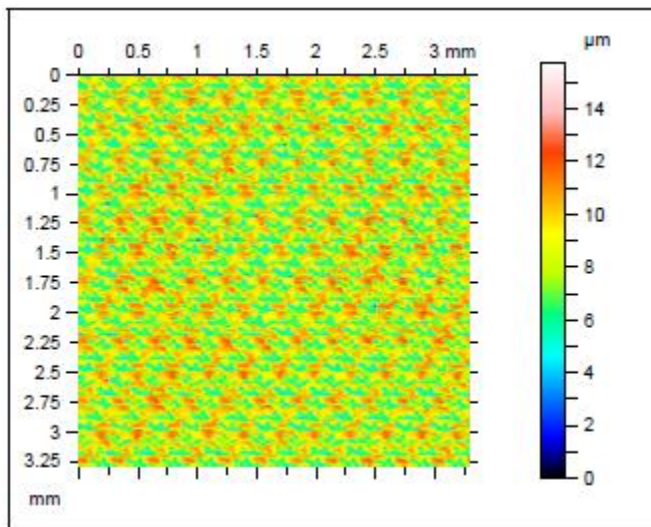

Fig 26

Experiment No. 3 ($a_p = 0,1\text{mm}$, $V = 1000\text{mm/min}$, $a = 0,05\text{mm}$)



Parametry wysokości		
Sq	1.79	μm
Ssk	-0.278	
Sku	2.02	
Sp	7.18	μm
Sv	8.53	μm
Sz	15.7	μm
Sa	1.55	μm

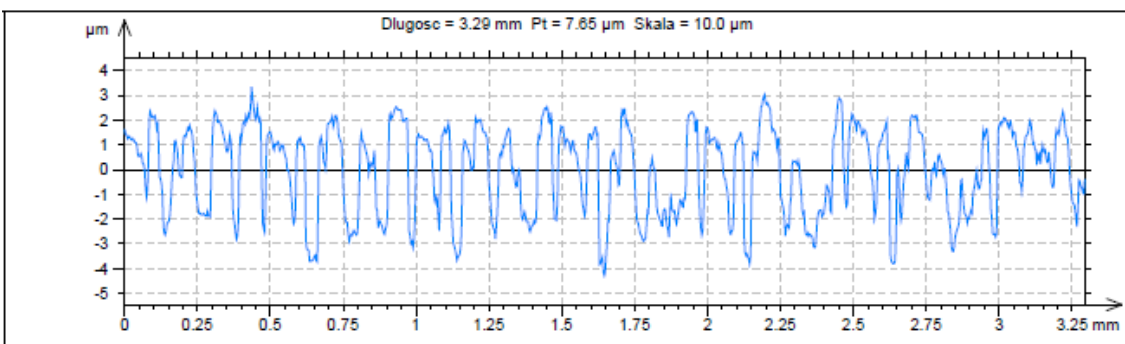
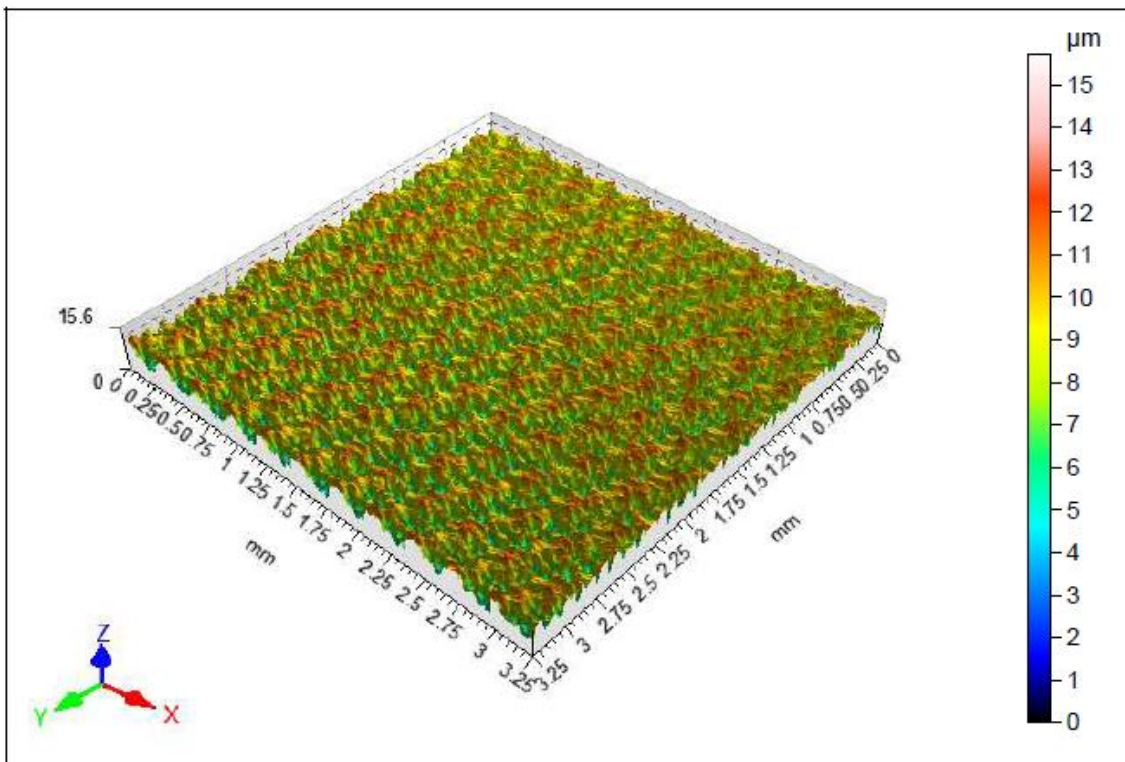

Fig 27 **Experiment No. 4** ($a_p = 0,1\text{mm}$, $V = 500\text{mm/min}$, $a = 0,1\text{mm}$)

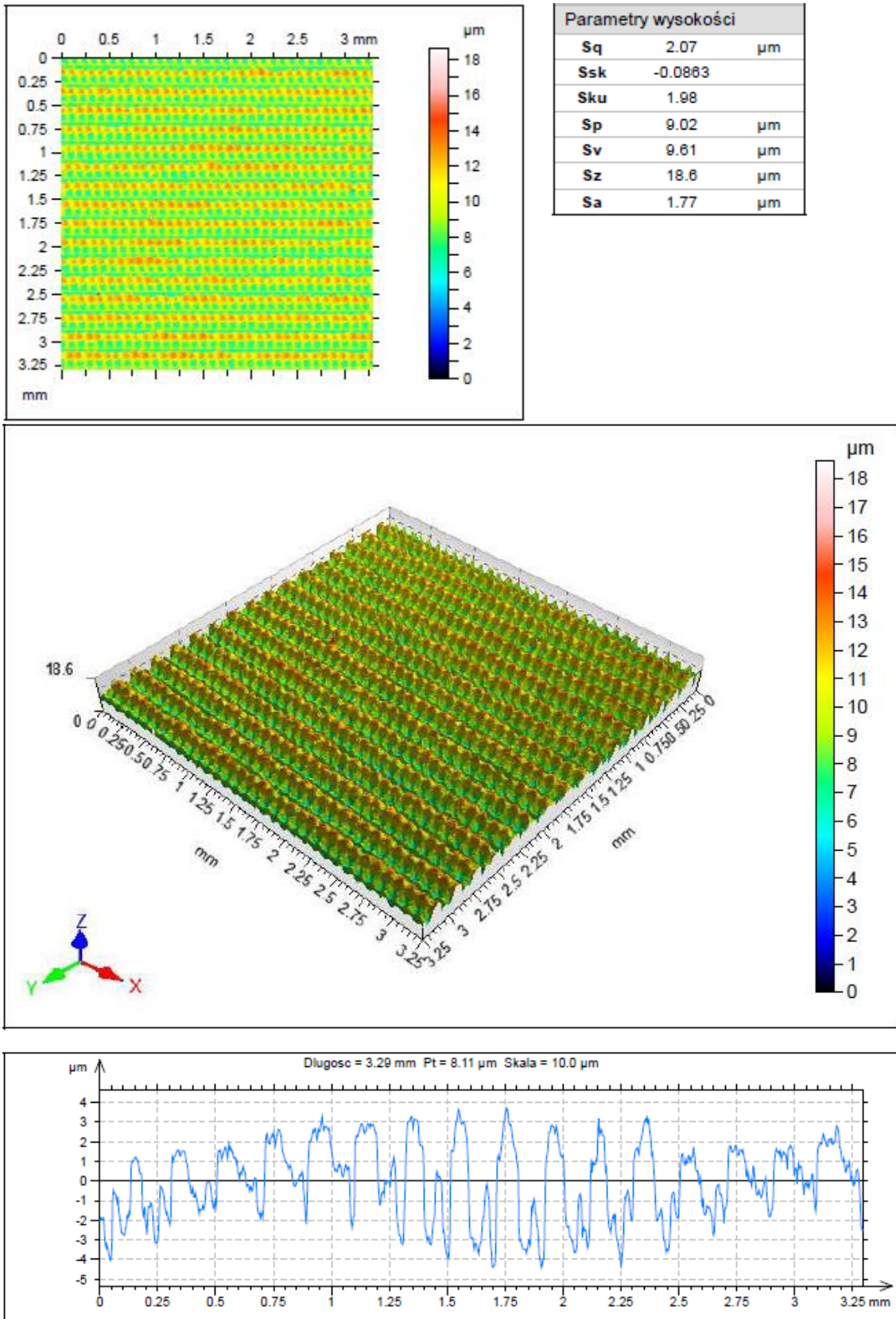

Fig 28

Experiment No. 5 ($a_p = 0,3\text{mm}$, $V = 1000\text{mm/min}$, $a = 0,075\text{mm}$)

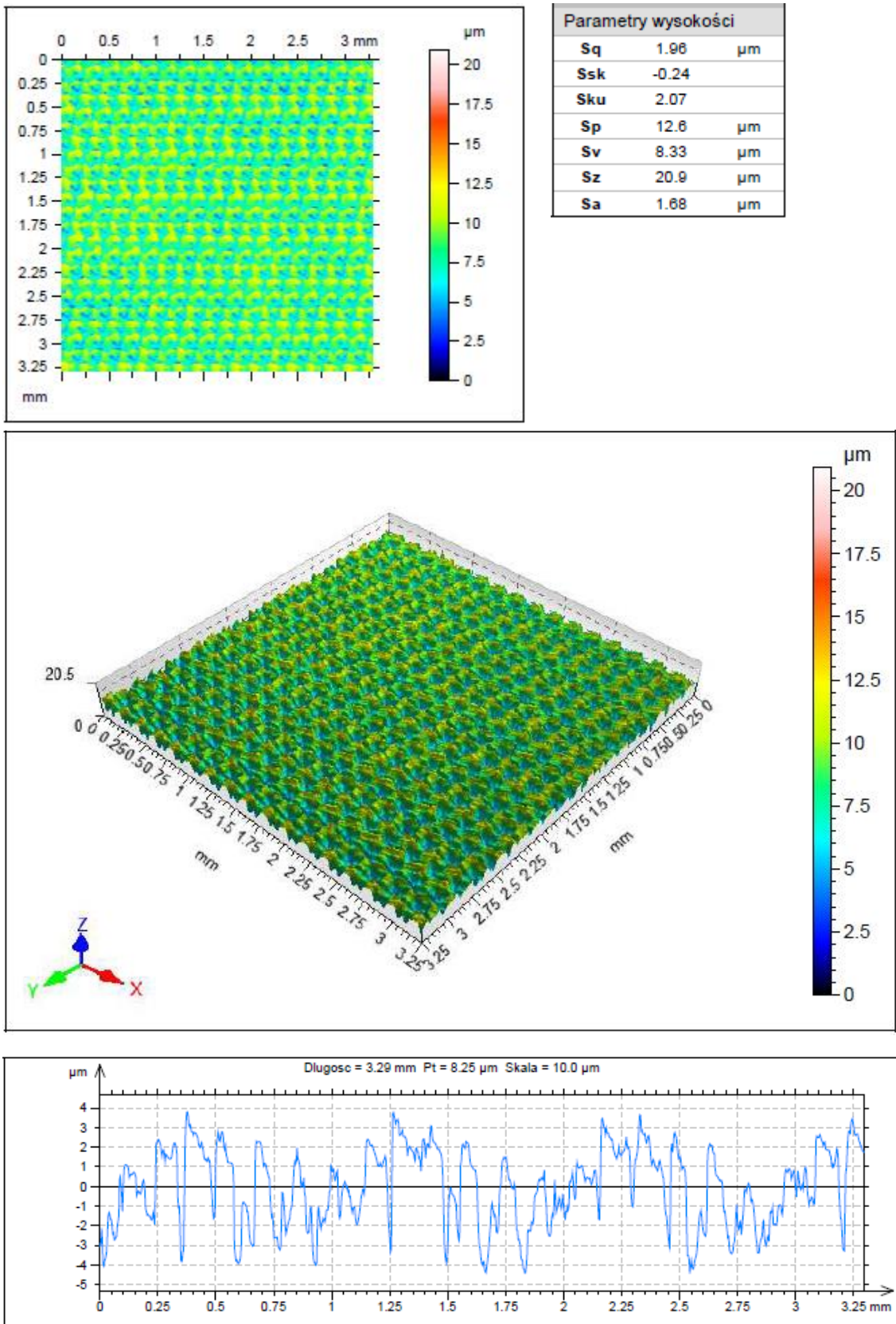
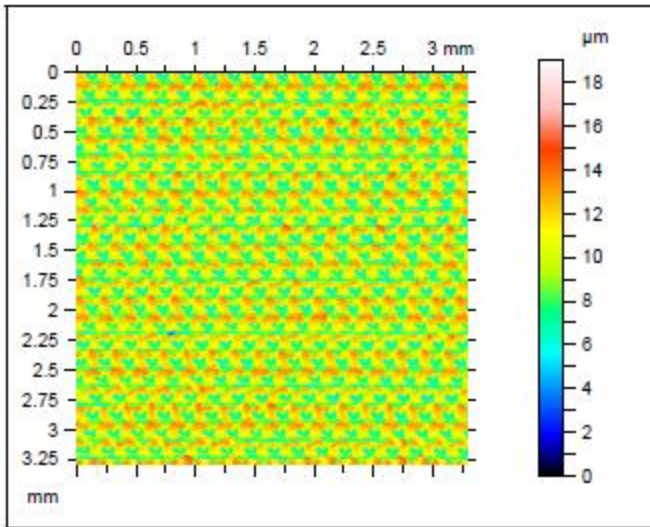

Fig 29

Experiment No. 6 ($a_p = 0,1\text{mm}$, $V = 1000\text{mm/min}$, $a = 0,075\text{mm}$)



Parametry wysokości		
Sq	2.06	μm
Ssk	-0.216	
Sku	1.93	
Sp	8.86	μm
Sv	10.1	μm
Sz	19.0	μm
Sa	1.79	μm

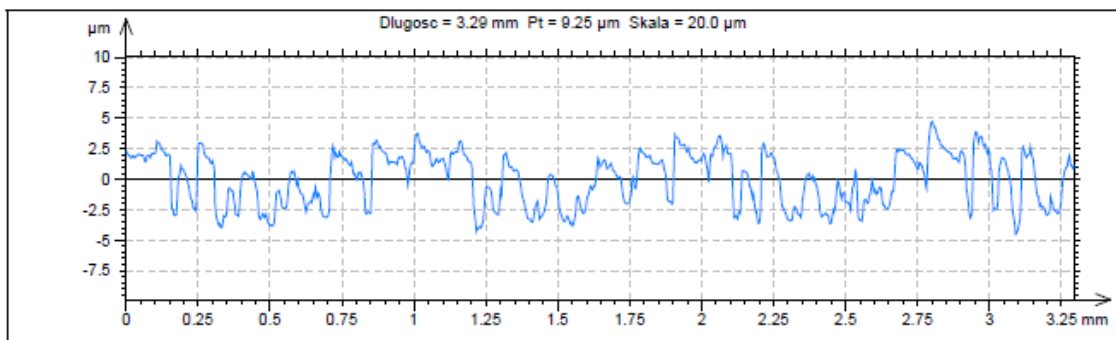
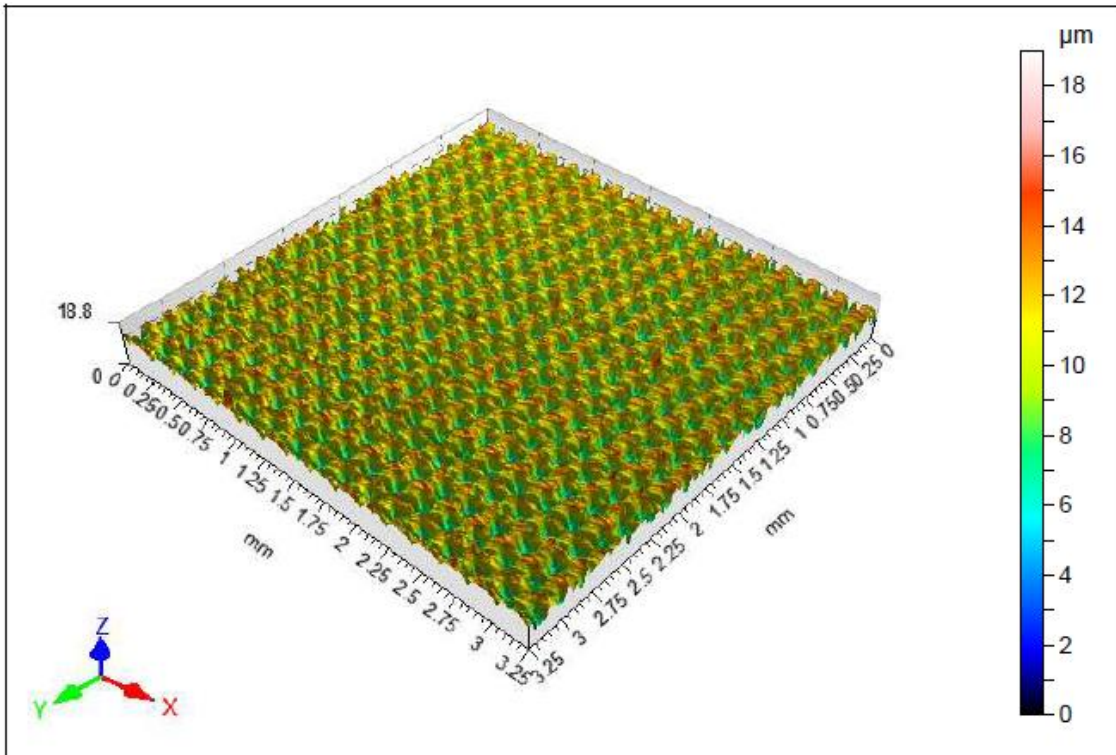

Fig 30 **Experiment No. 7** ($a_p = 0,2\text{mm}$, $V = 1500\text{mm/min}$, $a = 0,075\text{mm}$)

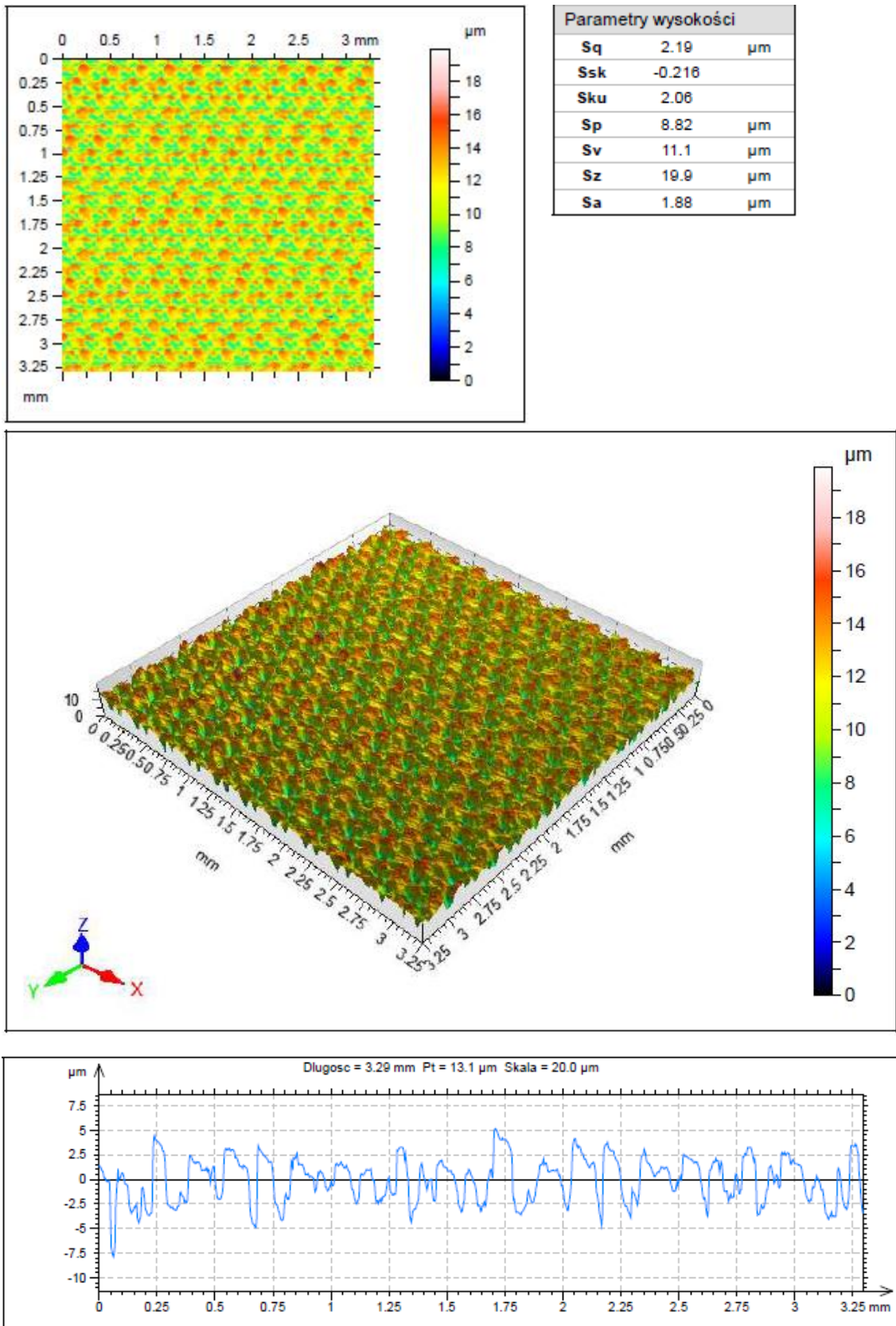
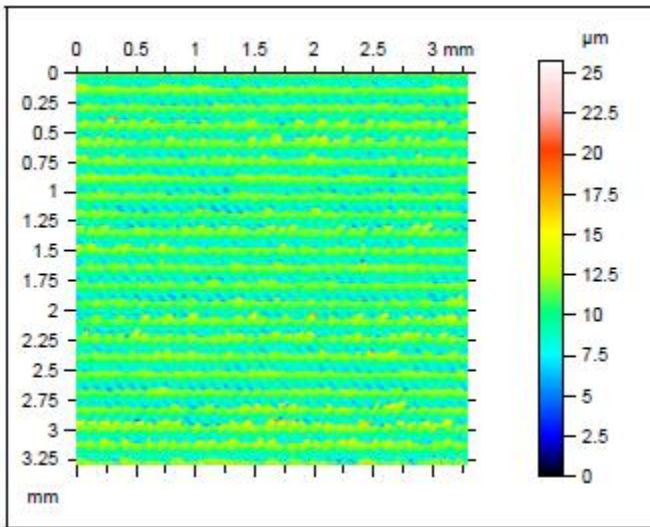

Fig 31

Experiment No. 8 ($a_p = 0,2\text{mm}$, $V = 500\text{mm/min}$, $a = 0,075\text{mm}$)



Parametry wysokości		
Sq	1.83	µm
Ssk	-0.225	
Sku	2.88	
Sp	15.7	µm
Sv	10.0	µm
Sz	25.7	µm
Sa	1.51	µm

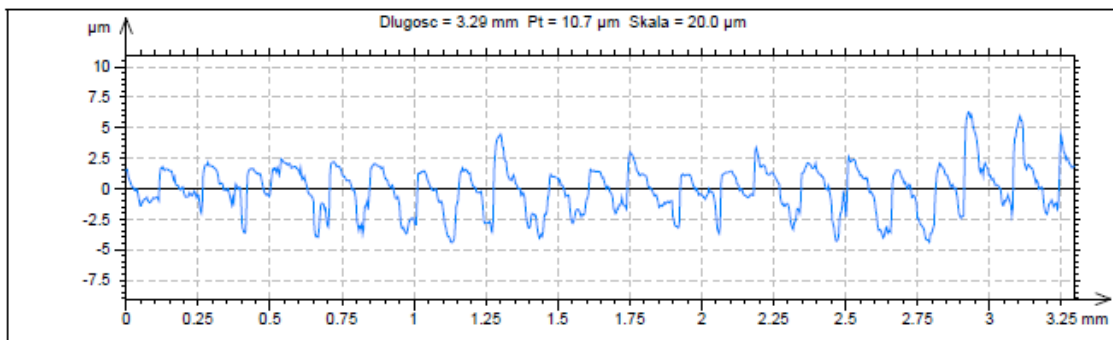
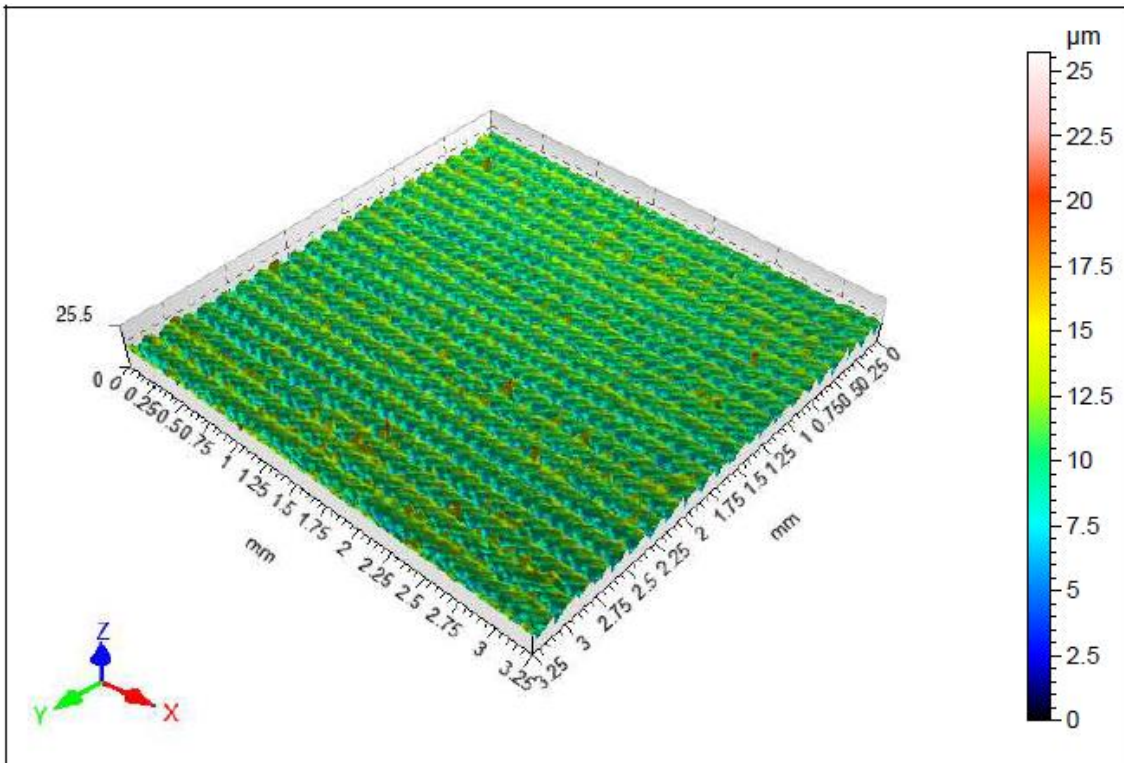
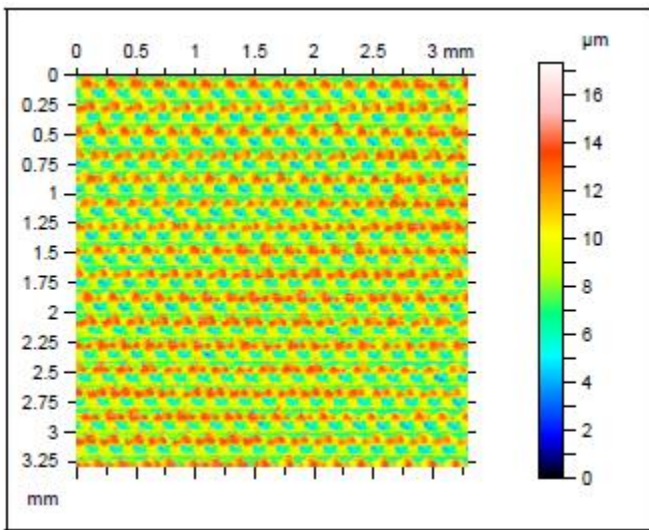

Fig 32

Experiment No. 9 ($a_p = 0,2\text{mm}$, $V = 1000\text{mm/min}$, $a = 0,1\text{mm}$)



Parametry wysokości		
Sq	2.41	μm
Ssk	-0.174	
Sku	2.24	
Sp	7.95	μm
Sv	9.40	μm
Sz	17.3	μm
Sa	2.01	μm

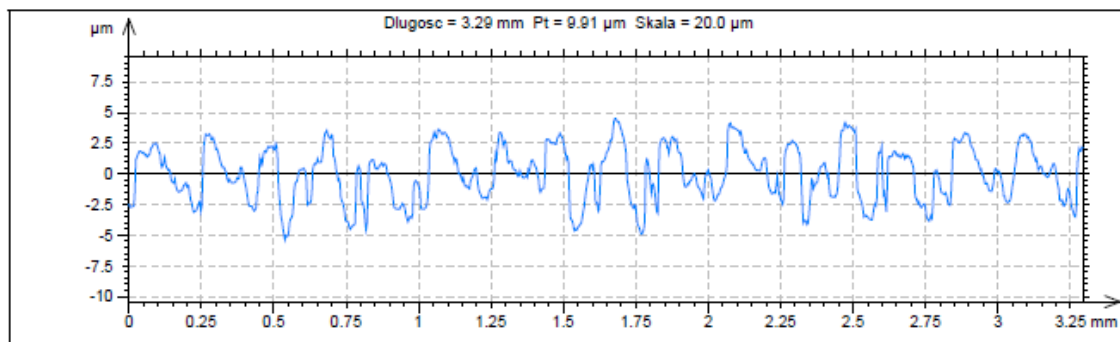
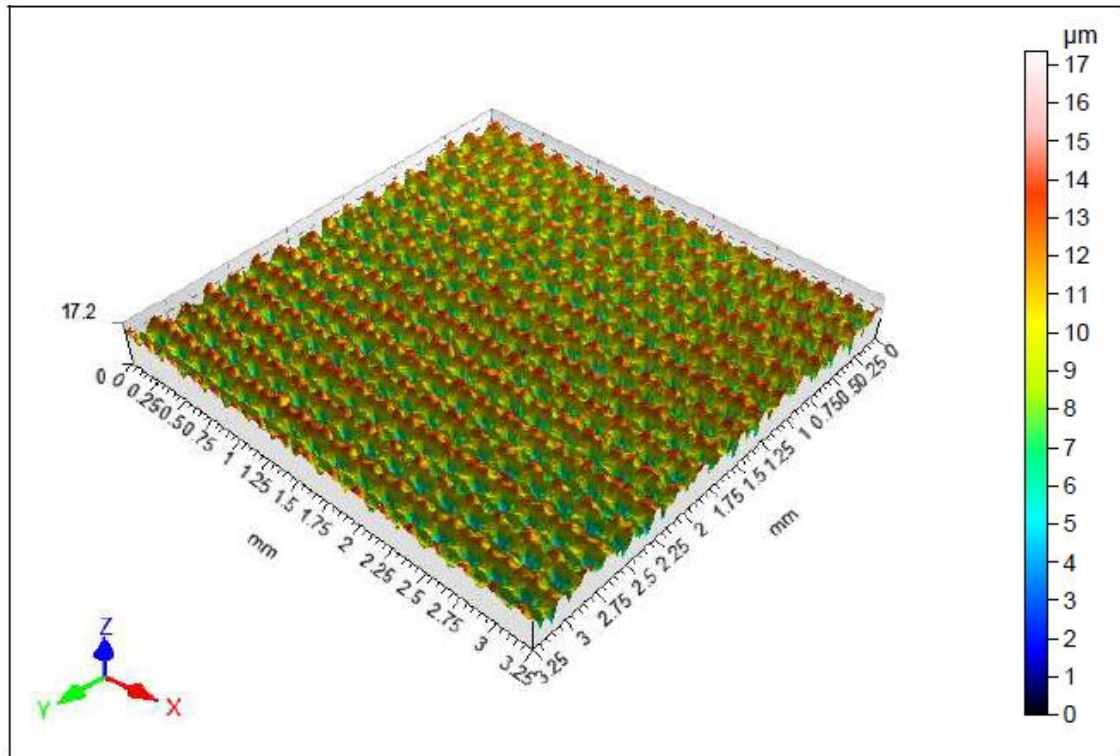
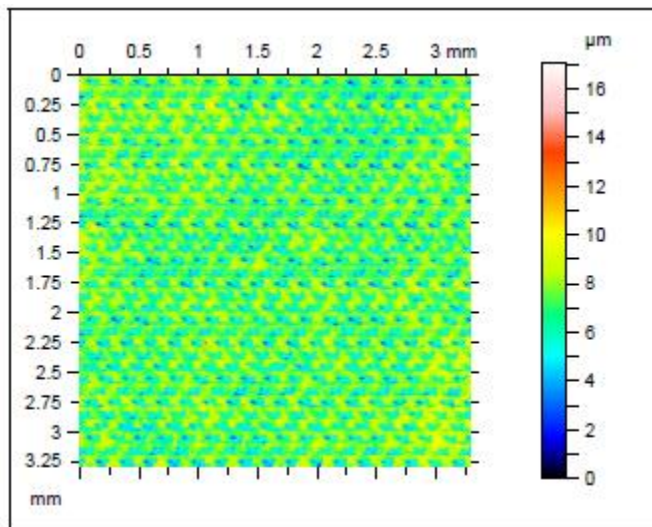

Fig 33

1 Experiment No. 10 ($a_p = 0,2\text{mm}$, $V = 1000\text{mm/min}$, $a = 0,05\text{mm}$)



Parametry wysokości		
Sq	1.38	µm
Ssk	-0.831	
Sku	3.20	
Sp	9.92	µm
Sv	7.11	µm
Sz	17.0	µm
Sa	1.10	µm

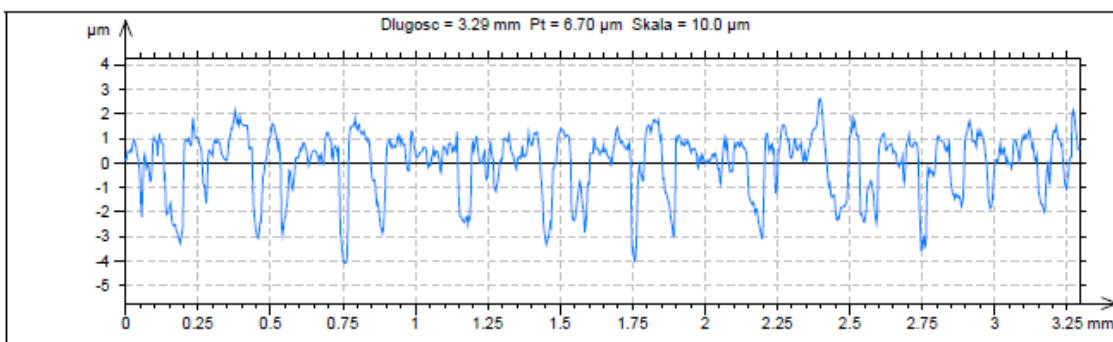
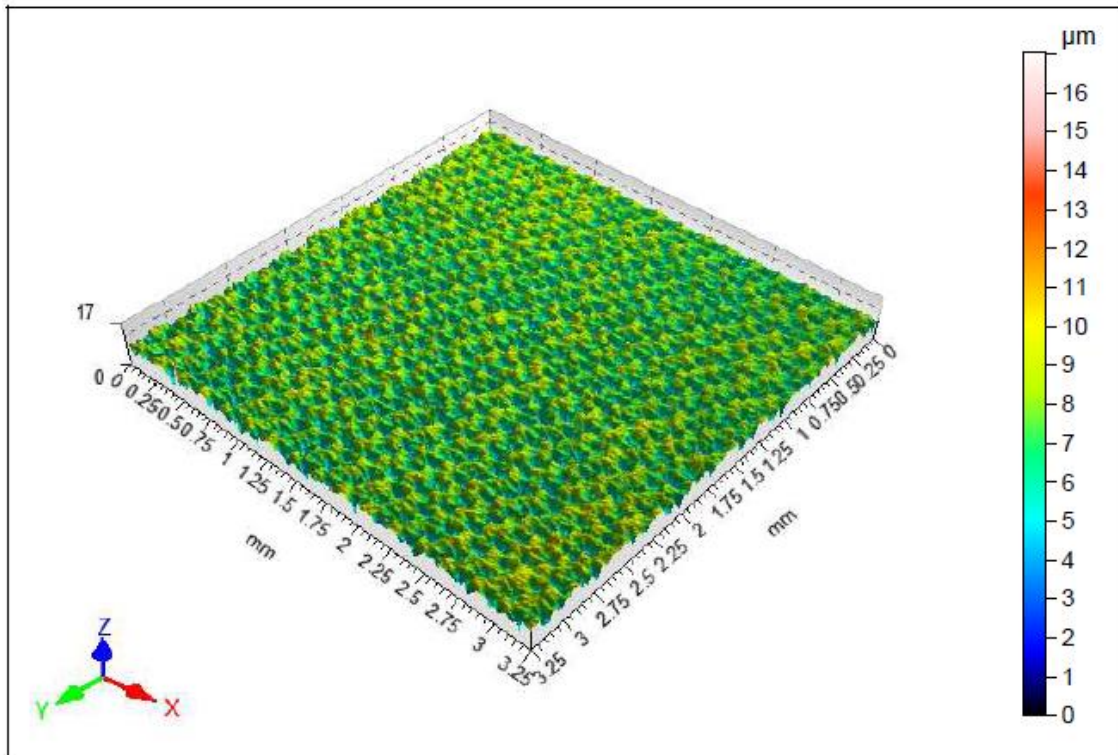
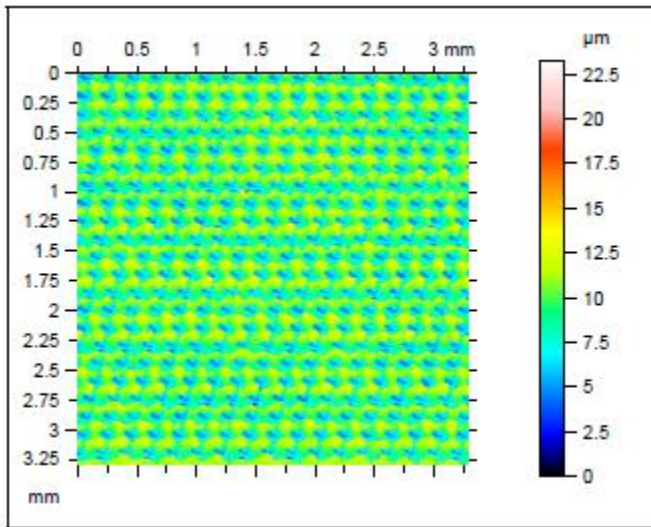
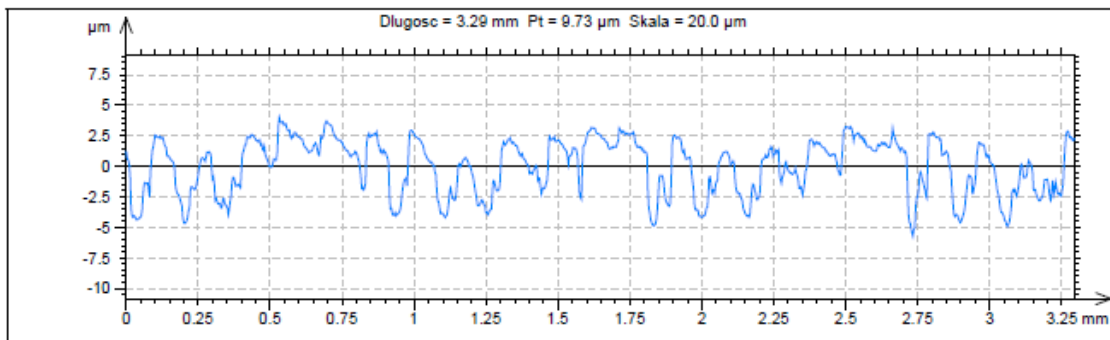
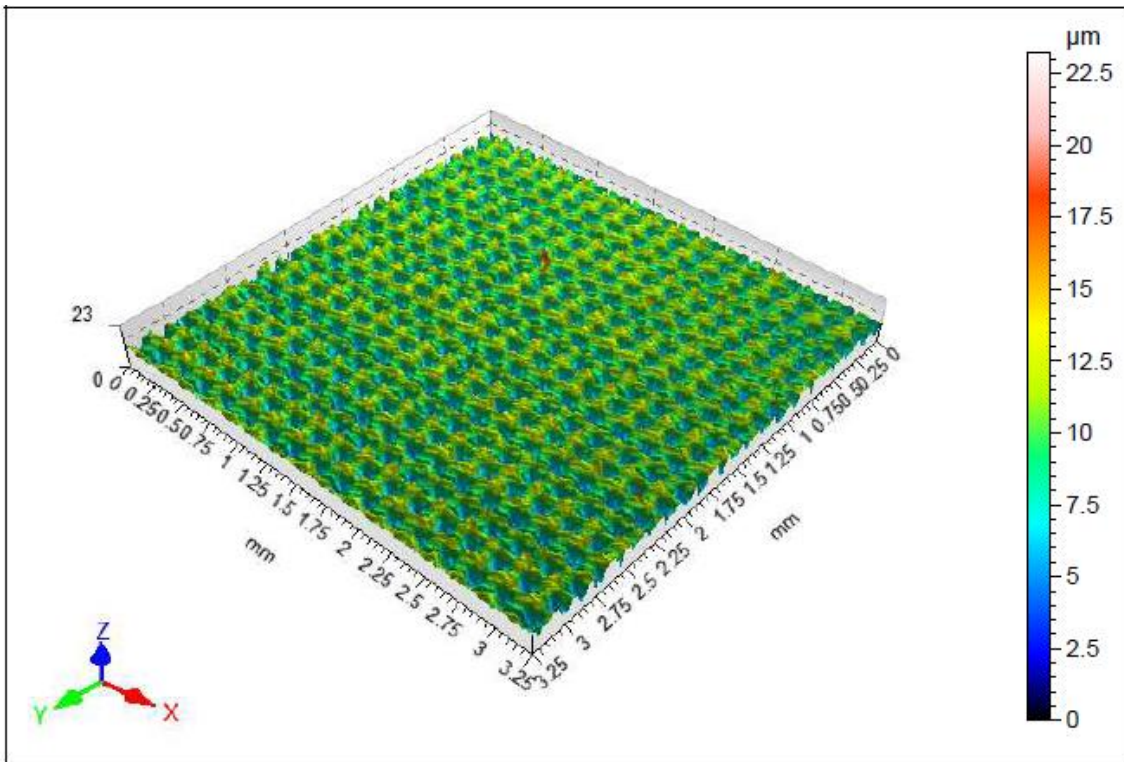

Fig 34

Experiment No. 11 ($a_p = 0,2\text{mm}$, $V = 1000\text{mm/min}$, $a = 0,075\text{mm}$)



Parametry wysokości		
Sq	2.18	μm
Ssk	-0.492	
Sku	2.34	
Sp	14.0	μm
Sv	9.26	μm
Sz	23.2	μm
Sa	1.83	μm



Calculations and results

Among other plans for three levels of the most convenient and useful to implementation experience in the field of machine technology plans (programs) Hartley experience. Depending on the distance and location of experimental points (In the space of input factors) with respect to the central point (zero), these plans can be built on hypercube.

Group plans built on a hypercube, denoted PS / DS-P: H_k^{53} , requires conducting experiments on three equally distant levels of variation of the input factors.

These plans are therefore much more effective than the plans PS / DK 3^n (especially for a number of input factors greater than three) and much simpler to implement than other three level plans. In practice, Hartley plans are used in the four or five factors input. If the input factors is less than four, the number of ongoing experiences required does not differ from those of the plans made for complete three- and two-level plans. If the input factors is more than five, the number of experiments necessary to implement is only a little less than that those required by other plans. Rarely also need to examine the more input factors.

The plans Hartley consists of three blocks of the experience:

- Repetition of fractional experience PS / DK 2^n ,
- Experience in stellar points of the arm $a = 1$,
- Experience in the central point of the plan.

The Hartley plan for three factors (Table 4):

Lp.	x_1	x_2	x_3
1	+	+	+
2	+	-	-
3	-	+	-
4	-	-	+
5	+	0	0
6	-	0	0
7	0	+	0
8	0	-	0
9	0	0	+
10	0	0	-
11	0	0	0

Table 6 – Hartey plan for three levels

The repetition of fractional Hartley plans should be constructed using defining contrasts with possibly large rows.

Generally, the higher orders of interactions are negligible and the resulting coefficients regression equations are not affected by them. In the case of identifying contrasts, coefficients regression equations are calculated from the formulas:

$$b_0 = \frac{a}{N} \sum_{i=1}^N \bar{y}_i - \frac{b}{N} \sum_{j=1}^k \sum_{i=1}^N x_{ji}^2 \bar{y}_i \quad b_k = \frac{1}{(\lambda_2 N)} \sum_{i=1}^N x_{ki} \bar{y}_i$$

$$b_{kl} = \frac{1}{(\lambda_3 N)} \sum_{i=1}^N x_{kli} \bar{y}_i$$

$$b_{kk} = \frac{c}{N} \sum_{i=1}^N x_{ki}^2 \bar{y}_i - \frac{b}{N} \sum_{i=1}^N \bar{y}_i - \frac{d}{N} \sum_{j=1}^k \sum_{i=1}^N x_{ji}^2 \bar{y}_i$$

Where a, b, c, d are the coefficients determined from Table 7 depending on the number of input factors, N - number of experiments (without repetition) k - the number of input factors (respondents).

k	$\lambda_2 N$	$\lambda_3 N$	$\lambda_4 N$	a	b	c	d	e	f
2	4	2	4	4,2002	2,8002	3,5000	-0,7000	-	-
3	6	4	6	3,3481	1,4344	5,5005	0,9568	5,5005	8,2508
4	10	8	10	3,2472	0,9551	8,5000	1,7190	8,5000	10,6250
5	18	16	18	3,7274	0,8181	13,5200	2,4550	-	-

Table 7 – Table for calculation of coefficients

Where the coefficients b_k and b_{kl} are calculated from the formulas for the effects of interaction:

$$b_k = \frac{e}{N} \left(\sum_{i=1}^N x_{ki} \bar{y}_i - \sum_{i=1}^N x_{lmi} \bar{y}_i \right)$$

$$b_{kl} = \frac{f}{N} \sum_{i=1}^N x_{kl} \bar{y}_i - \frac{e}{N} \sum_{i=1}^N x_{mi} \bar{y}_i$$

The conducting assessment of the repeatability, the conditions of implementation experience, the significance of the regression coefficients and the adequacy of the resulting regression equation have taken into account the fact that the value of a test (empirical) t ratio is calculated according to the adopted defining contrast, that depends on the formulas used for calculating the value of regression coefficients. Thus, when using empirical values of coefficients for the t -test it is calculated from the following formulas:

$$t_0 = \frac{|b_0|}{\sqrt{\frac{a}{rN} S^2(y)}}$$

$$t_k = \frac{|b_k|}{\sqrt{\frac{S^2(y)}{r(\lambda_2 N)}}}$$

Lp	y1	y2	y _r	S ² (y) _i	Y	Y _r -Y	(Y _r -Y) ²
1	0,032315	0,023885	0,0281	3,55E-05	0,344797	-0,3167	0,100297
2	-0,8441	-0,6239	-0,734	0,024244	-1,14737	0,413369	0,170874
3	-0,3197	-0,2363	-0,278	0,003478	-0,37637	0,098369	0,009677
4	-0,09925	-0,07336	-0,0863	0,000335	0,159131	-0,24543	0,060236
5	-0,276	-0,204	-0,24	0,002592	-0,31539	0,075393	0,005684
6	-0,2484	-0,1836	-0,216	0,0021	-0,19353	-0,02247	0,000505
7	-0,2484	-0,1836	-0,216	0,0021	-0,15039	-0,06561	0,004304
8	-0,25875	-0,19125	-0,225	0,002278	-0,34353	0,118525	0,014048
9	-0,2001	-0,1479	-0,174	0,001362	-0,26052	0,086518	0,007485
10	-0,95565	-0,70635	-0,831	0,031075	-0,79745	-0,03355	0,001126
11	-0,5658	-0,4182	-0,492	0,010893	-0,38772	-0,10428	0,010873
Σ	-----	-----	-----	0,080492	-----	-----	0,38511

Table 6 – Mean, variation and deviation.

$$t_{kk} = \frac{|b_{kk}|}{\sqrt{\frac{c-d}{rN} S^2(y)}}$$

$$t_{ij} = \frac{|b_{ij}|}{\sqrt{\frac{S^2(y)}{r(\lambda_3 N)}}}$$

Coefficients t absolute value greater than the value determined tkr Tablica 4 [5] adopted at a significance level and degrees of freedom $N = f(r - 1)$ are considered to be significant.

Mathematical analysis of the data:

The values calculated here are only of the S_{sk} parameter. The results of the calculations of the other parameters will be shown in Table 9.

Lp	X1	X2	X3	X12	X22	X32	X1x2	X1x3	X2x3	Y1	Y2
1	+	+	+	+	+	+	+	+	+	0,03231	0,0238
2	+	-	-	+	+	+	-	-	+	-0,8441	-0,6239
3	-	+	-	+	+	+	-	+	-	-0,3197	-0,2363
4	-	-	+	+	+	+	+	-	-	-0,0992	-0,0733
5	+	0	0	+	0	0	0	0	0	-0,276	-0,204
6	-	0	0	+	0	0	0	0	0	-0,2484	-0,1836
7	0	+	0	0	+	0	0	0	0	-0,2484	-0,1836
8	0	-	0	0	+	0	0	0	0	-0,2587	-0,1912
9	0	0	+	0	0	+	0	0	0	-0,2001	-0,1479
10	0	0	-	0	0	+	0	0	0	-0,9556	-0,7063
11	0	0	0	0	0	0	0	0	0	-0,5658	-0,4182
Σ	-0,3650	0,5794	1,6108	-1,526	-1,5110	-2,0752	0,9538	0,5704	-0,3416	-----	-----

Table 8

1. Calculation of the central (values input factors at 0):

$$x_{10} = \frac{ap_{max} + ap_{min}}{2} = \frac{0,3 + 0,1}{2} = 0,2$$

$$x_{20} = \frac{V_{max} + V_{min}}{2} = \frac{1500 + 500}{2} = 1000$$

$$x_{30} = \frac{a_{max} + a_{min}}{2} = \frac{0,1 + 0,05}{2} = 0,075$$

2. Calculation of unit of variation:

$$\Delta x_1 = \frac{ap_{max} - ap_{min}}{2} = \frac{0,3 - 0,1}{2} = 0,1$$

$$\Delta x_2 = \frac{V_{max} - V_{min}}{2} = \frac{1500 - 500}{2} = 500$$

$$\Delta x_3 = \frac{a_{max} - a_{min}}{2} = \frac{0,1 - 0,05}{2} = 0,025$$

3. Coding factors:

$$x_1 = \frac{a_p - x_{10}}{\Delta x_1} = \frac{a_p - 0,2}{0,1} \quad (5.1)$$

$$x_2 = \frac{V - x_{20}}{\Delta x_2} = \frac{V - 1000}{500} \quad (5.2)$$

$$x_3 = \frac{a - x_{30}}{\Delta x_3} = \frac{a - 0,075}{0,025} \quad (5.3)$$

$$y = R_a \quad (5.4)$$

4. The calculation of the regression coefficients:

$$\sum_{i=1}^N \bar{y}_i = -3,4642$$

$$b_0 = \frac{a}{N} \sum_{i=1}^{11} \bar{y}_i - \frac{b}{N} \sum_{j=1}^3 \sum_{i=1}^{11} x_{ij}^2 \bar{y}_i = -0,3877$$

$$b_1 = \frac{1}{\lambda_2 N} \sum_{i=1}^{11} x_{1j} \bar{y}_i = -0,0609$$

$$\mathbf{b}_2 = \frac{1}{\lambda_2 N} \sum_{i=1}^{11} x_{2j} \bar{y}_i = 0,0966$$

$$\mathbf{b}_3 = \frac{1}{\lambda_2 N} \sum_{i=1}^{11} x_{3j} \bar{y}_i = 0,2685$$

$$\mathbf{b}_{11} = \frac{c}{N} \sum_{i=1}^{11} x_{1j}^2 \bar{y}_i - \frac{b}{N} \sum_{i=1}^{11} \bar{y}_i - \frac{d}{N} \sum_{j=1}^3 \sum_{i=1}^{11} x_{ij}^2 \bar{y}_i = 0,1333$$

$$\mathbf{b}_{22} = \frac{c}{N} \sum_{i=1}^{11} x_{2j}^2 \bar{y}_i - \frac{b}{N} \sum_{i=1}^{11} \bar{y}_i - \frac{d}{N} \sum_{j=1}^3 \sum_{i=1}^{11} x_{ij}^2 \bar{y}_i = 0,1408$$

$$\mathbf{b}_{33} = \frac{c}{N} \sum_{i=1}^{11} x_{3j}^2 \bar{y}_i - \frac{b}{N} \sum_{i=1}^{11} \bar{y}_i - \frac{d}{N} \sum_{j=1}^3 \sum_{i=1}^{11} x_{ij}^2 \bar{y}_i = -0,1413$$

$$\mathbf{b}_{12} = \frac{1}{\lambda_3 N} \sum_{i=1}^{11} x_{12} \bar{y}_i = 0,2385$$

$$\mathbf{b}_{13} = \frac{1}{\lambda_3 N} \sum_{i=1}^{11} x_{13} \bar{y}_i = 0,1426$$

$$\mathbf{b}_{23} = \frac{1}{\lambda_3 N} \sum_{i=1}^{11} x_{23} \bar{y}_i = -0,0854$$

□

5. Assess reproducibility conditions for the implementation of the experiment:

- a) The calculation of the measurement error variance in the individual experiments:

$$s^2(\mathbf{y})_i = \frac{\sum_{i=1}^r (y_{ui} - \bar{y}_i)^2}{r - 1}$$

$$s^2(\mathbf{y})_1 = 3,55E - 05$$

$$s^2(\mathbf{y})_2 = 0,0242$$

$$s^2(\mathbf{y})_3 = 0,003$$

$$s^2(\mathbf{y})_4 = 0,0003$$

$$s^2(\mathbf{y})_5 = 0,0025$$

$$s^2(\mathbf{y})_6 = 0,0020$$

$$s^2(\mathbf{y})_7 = 0,0020$$

$$s^2(\mathbf{y})_8 = 0,0022$$

$$s^2(\mathbf{y})_9 = 0,0013$$

$$s^2(\mathbf{y})_{10} = 0,0310$$

$$s^2(\mathbf{y})_{11} = 0,0108$$

b) Calculation of the coefficient G based on the experimental results

$$G = \frac{S^2(y)_{imax}}{\sum_{i=1}^{11} S^2(y)_i} = 0,3860$$

c) The calculation of the number of degrees of freedom:

$$f_1 = N = 11$$

$$f_2 = r - 1 = 2 - 1 = 1$$

d) Determination of the critical factor G Tablica 8a [5]:

$$G_{kr} = 0,5715$$

$$G = 0,3860$$

Since $G < G_{kr}$ so the conditions for implementation experience to be considered repetitive.

6. Checking the significance of the coefficients of the equation:

a) Variance measurement errors:

$$s^2(y) = \frac{1}{11} \sum_{i=1}^{11} S^2(y)_i = 0,0804$$

b) Determining the number of degrees of freedom:

$$f = N(r - 1) = 11(2 - 1) = 11$$

c) Determination of the value t_{kr} decomposition t (with math tables):

$$t_{kr} = t_{(\alpha, f)} = t_{(0,05;11)} = 2,201$$

d) Determination of b_{0kr} :

$$b_{0kr} = t_{kr} \sqrt{\frac{a}{rN} S^2(y)} = 0,0734$$

If $|b_0| > b_{kr}$ then we can be consider it as significant.

In this case $|b_0| > b_{kr}$ so we consider it.

e) Determination of the critical value of b_k :

$$b_{kkkr} = t_{kr} \sqrt{\frac{S^2(y)}{r(\lambda_2 N)}} = 0,0543$$

Because:

$|b_1| > b_{kkkr}$ thus it is relevant

$|b_2| > b_{kkkr}$ thus it is relevant

$|b_3| > b_{kkkr}$ thus it is relevant

So coefficients b_1 , b_2 , b_3 are important for the adopted level of significance of α .

f) Calculation of the value of the critical factors b_{kkk} :

$$b_{kkkr} = t_{kr} \sqrt{\frac{S^2(y)(c-d)}{r N}} = 0,0843$$

Coefficients:

$$|b_1| > b_{kkkr}$$

$$|b_2| > b_{kkkr}$$

$$|b_3| > b_{kkkr}$$

therefore, they are all regarded as significant.

g) Calculation of the critical coefficients b_{kj} :

$$b_{kjkkr} = t_{kr} \sqrt{\frac{S^2(y)}{r(\lambda_4 N)}} = 0,06656$$

We have:

$$|b_{12}| > b_{kjkkr}$$

$$|b_{13}| > b_{kjkkr}$$

$$|b_{23}| > b_{kjkkr}$$

As they are all $> b_{kjkkr}$, all of the three coefficients are significant. When this coefficients are lower than the critical value they are not taken into account.

After the rejection of the irrelevant parameters of the regression, the equation is the following:

$$y = -0.387 - 0.061x_1 + 0.097x_2 + 0.268x_3 + 0.133x_1^2 + 0.141x_2^2 - 0.141x_3^2$$

$$+0.238x_1x_2 + 0,1426x_1x_3 - 0,0854x_2x_3 \quad (5.5)$$

Where $x_1, x_2 \dots$ are the coded factors that were previously calculated (5,1),(5,2) and (5,3).

7. Adequacy assessment of the model of research:

a) The adequacy of variance (k = 4 the number of words equation regression without intercept)

$$S_{ad}^2(y) = \frac{r \sum_{i=1}^{11} (y_{ui} - \bar{y}_i)^2}{N - k - 1} = 2 * \frac{0,385110096}{11 - 4 - 1} = 0,128$$

b) Calculation of the **F** factor:

$$F = \frac{S_{ad}^2(y)}{S^2(y)} = \frac{0,1283}{0,0073} = 17,5429$$

c) Determination of the number of degrees of freedom for the numerator and denominator:

$$f_1 = N - k - 1 = 11 - 9 - 1 = 1$$

$$f_2 = f_m = N(r - 1) = 11(2 - 1) = 11$$

d) Value of F Fisher-Snedecor test for the calculated number of degrees of freedom and the adopted level of significance of α . Tablica7 [5]:

$$F_{kr} = F_{(\alpha, f_1, f_2)} = F_{(\alpha, 1, 11)} = 4,8443$$

If:

$$F < F_{kr}$$

then the obtained regression equation is adequate.

For the parameter we are making the calculations here:

$$F = 17,5429$$

$$F_{kr} = 4,8443$$

So $F < F_{kr}$ which means that, in theory, the equation obtained for this case is not adequate.

8. Decoding equation. After substituting dependence (5.1) -(5.4) to the equation 5.5 we have:

$$\begin{aligned} Ssk = & -0.387 - 0.061 \frac{(ap - 0.2)}{0.1} + 0.097 \frac{(V - 1000)}{500} + 0.268 \frac{(a - 0,075)}{0,025} \\ & + 0.133 \left(\frac{ap - 0.2}{0.1} \right)^2 + 0.141 \left(\frac{V - 1000}{500} \right)^2 - 0.141 \left(\frac{a - 0.075}{0.025} \right)^2 \\ & + 0.238 \frac{(ap - 0.2)}{0.1} \frac{(V - 1000)}{500} + 0,1426 \frac{(ap - 0.2)}{0.1} \frac{(a - 0,075)}{0,025} \\ & - 0,0854 \frac{(V - 1000)}{500} \frac{(a - 0,075)}{0,025} \end{aligned}$$

Finally, this equation expresses the roughness S_{sk} factor of the input process steel milling X37CrMoV51:

$$Ssk = 13.3ap^2 + 570.4ap^2 + 0.00476apv - 225.6a^2 - 42790.69ap - \frac{427}{6250}av + 0.000001v^2 - 11.90928a + 5.122114v + 3431.516$$

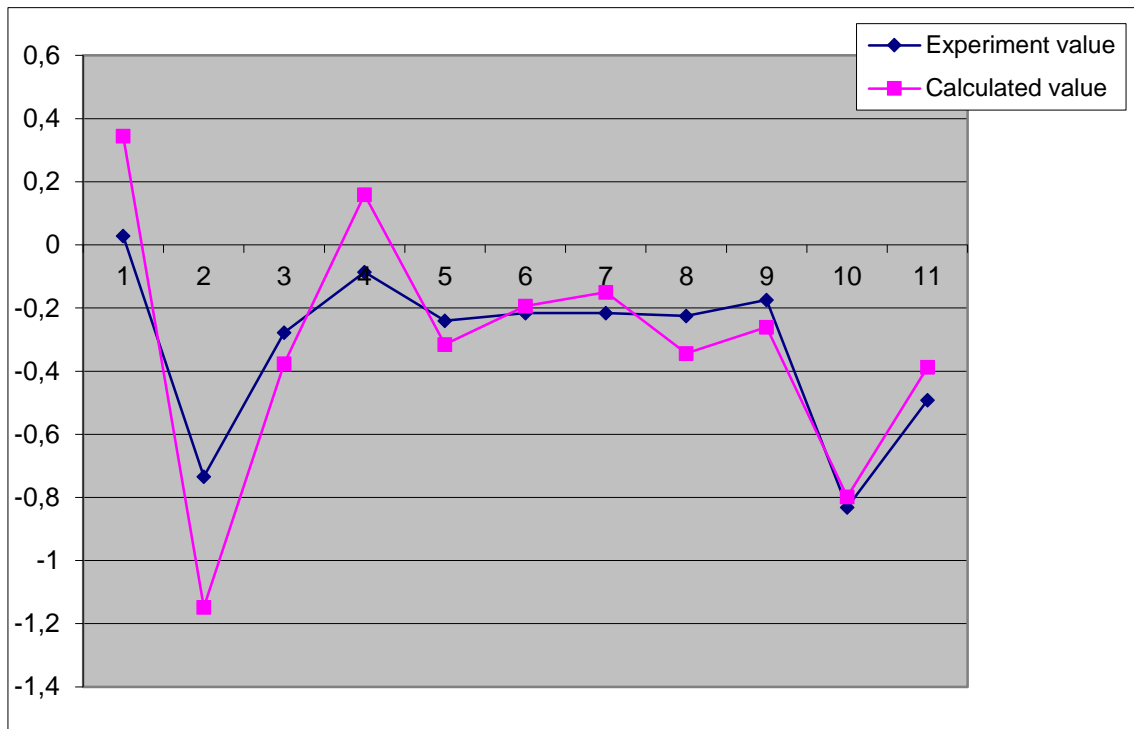

Fig 35 – Graphic results for the ssk parameter.

As said before $F < F_{kr}$ which means that, in theory, the equation obtained for this case is not adequate.

But as we can see in Fig 35, in this particular occasion the calculated values are adequate and follow quite accurately the experimental values obtained in the milling machine.

So in theory we could not predict accurately this outcome. This resemblance of the values should not be taken into account because it's a rare coincidence and won't happen very often.

The results for the rest of the parameters are exposed in the following table:

	S _q	S _a	S _z	S _v	S _p	S _{ku}	S _{sk}
S ²	0,1706	0,1220	18,2161	3,9025	5,4347	0,2844	0,0073
G	0,1393	0,1355	0,1483	0,1339	0,1855	0,2188	0,3861
G _{kr}	0,5715	0,5715	0,5715	0,5715	0,5715	0,5715	0,5715
b ₀	2,1190	1,7821	21,4087	9,4500	11,9909	2,3335	0,3877
b _{0kr}	0,3546	0,2999	3,6647	1,6962	2,0017	0,4579	0,0734
b ₁	0,1465	0,1472	1,3500	0,3567	1,7083	0,3800	0,0609
b ₂	0,2198	0,2072	0,3667	0,8083	0,4383	0,4067	0,0966
b ₃	0,4248	0,3705	2,3500	1,3667	0,9933	0,4433	0,2685
b _{kkkr}	0,2624	0,2219	2,7118	1,2552	1,4812	0,3388	0,0544
b ₁₁	0,0912	0,0330	0,9850	0,2703	0,7449	0,3287	0,1333
b ₂₂	0,0912	0,0730	1,8652	1,0648	0,7852	0,1414	0,1408
b ₃₃	0,2062	0,2130	3,7853	1,2304	2,5401	0,3914	0,1413
b _{kkkr}	0,4072	0,3443	4,2079	1,9477	2,2984	0,5257	0,0843
b ₁₂	0,3798	0,3283	3,4500	1,4775	1,9825	0,4250	0,2385
b ₁₃	0,2398	0,2183	2,0000	0,9375	1,0625	0,4050	0,1426
b ₂₃	0,1948	0,1933	1,5500	0,0925	1,6275	0,5350	0,0854
b _{jkkkr}	0,3214	0,2718	3,3213	1,5372	1,8141	0,4150	0,0666
F	3,2328	3,5150	1,9016	0,8920	2,0188	2,2904	17,5429
F _{kr}	2,9480	2,9480	2,8692	2,8962	3,0123	3,2039	4,8443

Table 9 – Results of all the parameters.

We make sure taking a look at the values in this table that in all the parameters $G < G_{KR}$ so the conditions for implementation experience to be considered repetitive in every single one of the cases.

We also compare and select the different values of b_0 with b_{0kr} , b_1 b_2 b_3 with b_{kkkr} , b_{11} b_{22} b_{33} with b_{kkkr} , b_{12} b_{13} b_{23} with b_{jkkkr} to see which of these will be significant for the equations of the parameters.

Coded equations of the parameters:

$$S_q = 2.119 + 0.4248 \frac{(a - 0,075)}{0,025} + 0.3798 \frac{(ap - 0.2)}{0.1} \frac{(V - 1000)}{500}$$

$$S_a = 1.7821 + 0.3705 \frac{(a - 0,075)}{0,025} + 0.3283 \frac{(ap - 0.2)(V - 1000)}{0.1 \cdot 500}$$

$$S_z = 21.4087 + 3.45 \frac{(ap - 0.2)(V - 1000)}{0.1 \cdot 500}$$

$$S_v = 9.45 + 1.3667 \frac{(a - 0,075)}{0,025}$$

$$S_p = 11.9909 + 1.7083 \frac{(ap - 0.2)}{0.1} + 2.5401 \left(\frac{a - 0.075}{0.025} \right)^2$$

$$+ 1.9825 \frac{(ap - 0.2)(V - 1000)}{0.1 \cdot 500}$$

$$S_{ku} = 2.3335 + 0.38 \frac{(ap - 0.2)}{0.1} - 0.4067 \frac{(V - 1000)}{500} - 0.4433 \frac{(a - 0,075)}{0,025}$$

$$- 0.4250 \frac{(ap - 0.2)(V - 1000)}{0.1 \cdot 500} + 0.535 \frac{(V - 1000)(a - 0,075)}{500 \cdot 0,025}$$

$$S_{sk} = -0.387 - 0.061 \frac{(ap - 0.2)}{0.1} + 0.097 \frac{(V - 1000)}{500} + 0.268 \frac{(a - 0,075)}{0,025}$$

$$+ 0.133 \left(\frac{ap - 0.2}{0.1} \right)^2 + 0.141 \left(\frac{V - 1000}{500} \right)^2 - 0.141 \left(\frac{a - 0.075}{0.025} \right)^2$$

$$+ 0.238 \frac{(ap - 0.2)(V - 1000)}{0.1 \cdot 500} + 0.1426 \frac{(ap - 0.2)(a - 0,075)}{0.1 \cdot 0,025}$$

$$-0,0854 \frac{(V - 1000) (a - 0,075)}{500 \cdot 0,025}$$

And the final equations of the parameters:

$$S_q = 2.3638 + 0.007596apv - 7.596ap + 0.016992a - 0.001519v \quad (5.6)$$

$$S_a = 1.9838 + 0.006566apv - 6.566ap + 0.01482a - 0.001313v \quad (5.7)$$

$$S_z = 35.2087 + 0.069apv - 69ap - 0.0138v \quad (5.8)$$

$$S_v = 0.054668a + 5.3499 \quad (5.9)$$

$$S_p = 0.03965apv + 4064.16a^2 - 22.567ap - 609.624a - 0.00793v + 39.3652 \quad (5.10)$$

$$S_{ku} = -0.0085apv + 12.3ap + 0.000043av - 0.060532a - 0.002323v + 5.2268 \quad (5.11)$$

$$S_{sk} = 13.3ap^2 + 570.4ap^2 + 0.00476apv - 225.6a^2 - 42790.69ap - \frac{427}{6250}av + 0.000001v^2 - 11.90928a + 5.122114v + 3431.516 \quad (5.12)$$

Finally, we check whether $F < F_{kr}$ in each of the parameters to see if the obtained regression equations are adequate.

The obtained equations for the parameters: S_{ku} , S_p , S_v and S_z meet the condition exposed above.

The parameters Sq and Sa don't meet this condition but as we can see the values of F and F_{kr} are really close so we could consider them as adequate.

For the parameter Ssk $F \gg F_{kr}$ so the obtained equation is not valid. We wouldn't be able to calculate precisely this parameter.

Results analysis and conclusions

To fully understand the impact of the input factors on the finished surface, to be analyzed obtained by profilometer measurements values of the roughness profile of the milled samples. Especially you have to consider, these SGP parameters, which as a result of mathematical analysis, while maintaining reproducibility experience, determined the relevant and adequate regression equation. These conditions are fulfilled parameters S_a , S_q , S_z , S_v , S_p and S_{ku} .

Best quality of surface topography after treatment, characterized by the parameter S_a , was obtained for sample 2, $S_a = 0.727$, was due to the factors of adopted values the input of the test process, which amounted to a depth of cut $a_p = 0.3$ [mm] (level variation) for the cutting speed $V = 500$ [mm/min], for width of cut $a=0.05$. The biggest roughness R_a of describing the parameter and thus the worst finished surface was found for sample 9. The value of the average of the measurements was $R_a = 2.01$ [μm]. The corresponding levels of volatility have adopted values: depth of cut $a_p = 0.2$ [mm] (level variation) for the cutting speed $V = 1000$ [mm/min], for width of cut $a=0.1$ [mm].

Results of parameters:

-The parameter S_q takes the smallest roughness values to the treated surface of the sample nr. 2. Average of measurements S_q for the samples amounted to $1,90[\mu\text{m}]$. The greatest value of the root mean square height of the surface was measured for sample nr. 9 for the values: depth of cut $a_p = 0.2$ [mm] (level variation) for the cutting speed $V = 1000$ [mm/min], for width of cut $a=0.1$ [mm].

-The parameter S_{sk} takes the smallest roughness values to the treated surface of the sample nr. 4 (depth of cut $a_p = 0.1$ [mm] (level variation) for the cutting speed $V = 500$ [mm/min], for width of cut $a=0.1$ [mm]). Average of measurements S_{sk} for the samples amounted to $-0,31[\mu\text{m}]$. The greatest value of the skewness of height distribution measured for sample nr. 10 (depth of cut $a_p = 0.2$ [mm] (level variation) for the cutting speed $V = 1000$ [mm/min], for width of cut $a=0.05$ [mm]).

-The parameter S_{ku} takes the smallest roughness values to the treated surface of the sample nr. 64 (depth of cut $a_p = 0.1$ [mm] (level variation) for the cutting speed $V = 1000$ [mm/min], for width of cut $a=0.075$ [mm]). Average of kurtosis of height distribution measurements S_{ku} for the samples amounted to $2,44[\mu\text{m}]$. The

greatest value of the maximum height of the roughness profile measured for sample nr. 2 (depth of cut $a_p = 0.3$ [mm] (level variation) for the cutting speed $V = 500$ [mm/min], for width of cut $a=0.05$ [mm]).

-The parameter S_p takes the smallest roughness values to the treated surface of the sample nr. 3 (depth of cut $a_p = 0.1$ [mm] (level variation) for the cutting speed $V = 1000$ [mm/min], for width of cut $a=0.05$ [mm]). Average of the maximum height of peaks measurements S_p for the samples amounted to $10,61[\mu\text{m}]$. The greatest value of the maximum height of the roughness profile measured for sample nr. 8 (depth of cut $a_p = 0.2$ [mm] (level variation) for the cutting speed $V = 500$ [mm/min], for width of cut $a=0.075$ [mm]).

-The parameter S_v takes the smallest roughness values to the treated surface of the sample nr. 2 (depth of cut $a_p = 0.3$ [mm] (level variation) for the cutting speed $V = 500$ [mm/min], for width of cut $a=0.05$). Average of the maximum height of valleys measurements S_v for the samples amounted to $9.20[\mu\text{m}]$. The greatest value of the maximum height of the roughness profile measured for sample nr. 1 (depth of cut $a_p = 0.3$ [mm] (level variation) for the cutting speed $V = 1500$ [mm/min], for width of cut $a=0.1$ [mm]).

-The parameter S_z takes the smallest roughness values to the treated surface of the sample nr. 2 (depth of cut $a_p = 0.3$ [mm] (level variation) for the cutting speed $V = 500$ [mm/min], for width of cut $a=0.05$). Average of maximum height of the surface measurements S_z for the samples amounted to $19.80[\mu\text{m}]$. The greatest value of the maximum height of the roughness profile measured for sample nr. 8 (depth of cut $a_p = 0.2$ [mm] (level variation) for the cutting speed $V = 500$ [mm/min], for width of cut $a=0.075$ [mm]).

-The parameter S_a takes the smallest roughness values to the treated surface of the sample nr. 2 (depth of cut $a_p = 0.3$ [mm] (level variation) for the cutting speed $V = 500$ [mm/min], for width of cut $a=0.05$). Average of arithmetical mean height of the surface measurements S_a for the samples amounted to $1.61[\mu\text{m}]$. The greatest value of the maximum height of the roughness profile measured for sample nr. 9 (depth of cut $a_p = 0.2$ [mm] (level variation) for the cutting speed $V = 1000$ [mm/min], for width of cut $a=0.1$ [mm]).

Development of new technologies, implement innovative products determines that both during design and implementation of production processes need to be selected in such value processing parameters, which grants the maximum value of the adopted criterion. To do this, in the first stage to develop a mathematical

model of the test process and what's with that directly binds the analysis of the factors involved in the experiment (evaluate the impact of the assumed impact of the input parameters on the resulting factor, check the adequacy of the determined regression equation).

The analyzed milling process of the steel X37CrMoV51 had in order to find a mathematical model for the geometric structure of the parameters of the surface after treatment. The experiment was used a static three-factors-three-levels Hartley plan, whose main advantage is that it is effective unlike the plans PS / DK $3n$ (static determined complete three level plan for n factors in the input) where occurs that a rapid increase in the number of experiences is needed with the increase in the number of input parameters. Therefore, planning a three-level PS / DK $3n$ is little practical and model identification is more difficult to plan than for the Hartley. Executing an experiment, in which the influence of the size of the input to the finished surface regression equations were determined for the selected parameters of the roughness profile. Terms of realization of experience shown to be reproducible parameters S_a , S_q , S_z , S_v , S_p and S_{ku} .

As a result of mathematical analysis has been proven that the parameter S_{sk} studies were conducted with satisfactory reproducibility, coefficients of regression equation were significant but the same equation itself (5.12) is shown to be inadequate - inconsistent with the real model of the test process. The inadequacy of this does not lead to the continuous dependence of mathematical parameters analyzed for the SGP and discredit the adopted model studies.

The static calculations for the experiment parameters of roughness profile R_a ... showed that the experience was carried out with satisfactorily repeatability and that the obtained regression equations (5.6 - 5.10) were significant and relevant. As a result, we received mathematical models based on these equations, which are linear functions of the parameters S_q (5.6), S_a (5.7), S_z (5.8), S_v (5.9), S_p (5.10), S_{ku} (5.11) require monitoring at the depth of milling, cutting speed and width of the cut. Knowing them we can choose and set the parameters on milling machines to make sure that the finished surface is optimal.

The study and analysis of their results lead to the formulation of the following final conclusions:

1. The proposed method allows studies to analyze the significance of the impact factors of the input process steel milling X37CrMoV51 (depth of cut, cutting speed, width of cut) on the finished surface.

2. The resulting mathematical model as a result of the adopted plan Hartley allows determination of selected parameters SGP at an optimal level. This is of great importance, because high-quality surfaces designed or manufactured parts determines its improved operational efficiency, reliable and precise interacts with the surfaces of other elements.

3. Knowledge of the mathematical model of the test process for the selected parameters SGP allows to predict its course and behavior in different conditions. Input parameters can be imposed by the technologist or machine operator by the value adjustment milling in order to obtain the appropriate quality of the machined surface.

4. Appointed in the test experiment mathematical model - if the conditions are repeatable experience, coefficients of regression equations relevant and appropriate can be part of parametric optimization, which together with the optimization of the structures are multi-criteria is crucial Studies in quality control as well as in the design of modern technology and parts new-generation machines.

Bibliography

1 - Arizmendi M., Model for prediction of surface topography in peripheral milling tool considering vibration, CIRP Annals – Manufacturing Technology, Volume 58, Issue 1, 2009, Pages 93–96.

2 - Buj-Corral, Irene., Surface topography in ball-end milling processes as a function of feed per tooth and radial depth of cut, International Journal of Machine Tools and Manufacture, Volume 53, Issue 1, February 2012, Pages 151–159.

3 - Dong Yang, Surface topography analysis and cutting parameters optimization for peripheral milling titanium alloy Ti–6Al–4V, International Journal of Refractory Metals and Hard Materials, Volume 90, August 2016, Pages 25–35.

4 - N.E. Karkalos, Surface roughness prediction for the milling of Ti–6Al–4V ELI alloy with the use of statistical and soft computing techniques, Measurement, Volume 90, August 2016, Pages 25–35.

5 - Metodyka eksperymentu

6 - Introduction to Basic Manufacturing Processes and Workshop Technology