



Probabilistic fatigue S-N curves derivation for notched components

P. Raposo, J.A.F.O. Correia, A.M.P. De Jesus, R.A.B. Calçada

INEGI and CONSTRUCT, Faculty of Engineering, University of Porto, Rua Dr. Roberto Frias, 4200-465 Porto, Portugal

praposo@inegi.up.pt, <http://orcid.org/0000-0002-9415-8209>

jacorreia@inegi.up.pt, <http://orcid.org/0000-0002-4148-9426>

ajesus@fe.up.pt, <http://orcid.org/0000-0002-1059-715X>

ruiabc@fe.up.pt, <http://orcid.org/0000-0002-2375-7685>

G. Lesiuk

Faculty of Mechanical Engineering, Department of Mechanics, Material Science and Engineering, Wrocław University of Science and Technology, Smoluchowskiego 25, 50-370 Wrocław, Poland

Grzegorz.Lesiuk@pwr.edu.pl, <https://orcid.org/0000-0003-3553-6107>

M. Hebdon

Virginia Polytechnic Institute and State University, Department of Civil Engineering, Blacksburg, United States

mhebdon@vt.edu

A. Fernández-Canteli

Department of Construction and Manufacturing Engineering, Univ. of Oviedo, 33203 Gijón, Spain

afc@uniovi.es, <http://orcid.org/0000-0001-8071-9223>

ABSTRACT. Europe has a number of ancient riveted metallic bridges, constructed during the second half of the 19th century up to the middle of the 20th century, which are still in operation. In this paper, a unified approach is presented to generate probabilistic S-N curves to be applied to structural components, accounting for uncertainties in material properties. The approach is particularly demonstrated for a plate with a circular hole, made of puddle iron from the Portuguese Eiffel Bridge. This paper presents an extension of the local strain-based fatigue crack propagation model proposed by Noroozi et al. The latter model is applied to derive the probabilistic fatigue crack propagation field (p - S - N_p field). The probabilistic fatigue crack initiation field (p - S - N_i field) is determined using a notch elastoplastic approach, to calculate the fatigue failure of the first elementary material block ahead of the notch root.

KEYWORDS. Fatigue; Probabilistic Approach; Puddle Iron; Notched Plate; Local Approaches.



Citation: Raposo, P., Correia, J.A.F.O., De Jesus, A.M.P., Calçada, R.A.B., Lesiuk, G., Hebdon, M., Fernández-Canteli, A., Probabilistic fatigue S-N curves derivation for notched components, *Frattura ed Integrità Strutturale*, 42 (2017) 105-118.

Received: 30.04.2017

Accepted: 31.05.2017

Published: 01.10.2017

Copyright: © 2017 This is an open access article under the terms of the CC-BY 4.0, which permits unrestricted use, distribution, and reproduction in any medium, provided the original author and source are credited.



INTRODUCTION

The majority of fatigue models proposed in the literature are deterministic. Their application for design purposes requires additional safety margins defined with supplementary statistical arguments in order to allow the establishment of an appropriate safe design. In this paper, a probabilistic approach is applied to generate probabilistic S-N curves for notched details such as a notched plate (plate with circular hole) made of puddle iron from the Eiffel bridge, based on local strain fatigue approaches [1]. The plate with a circular hole is of interest since it shows similitudes with the riveted plates. Their study allows a better understanding of the fatigue behaviour of riveted joints. The model applied in this paper is an extension of the fatigue crack propagation model proposed by Noroozi et al. [2-4] which is based on a local strain approach to fatigue. The latter model, named as UniGrow model, is a fatigue crack propagation model based on residual stress considerations [2,3]. The selected model is applied in this paper to derive a probabilistic fatigue crack propagation field (p -S- N_p field) for a detail tested under stress control and a null stress R-ratio. The fatigue crack propagation is considered a damaging process consisting on continuous crack initializations over adjacent material representative elements of a size, q^* . Based on pure fatigue crack growth data, the material representative element size, q^* , was previously estimated as can be consulted in references [5-9]. Probabilistic fatigue crack initiation fields (p -S- N_i fields) are determined using an elastoplastic approach together with the material p -SWT-N fields. Predicted global p -S-N fields (combination of fatigue crack initiation and propagation phases) are compared with experimental S-N fatigue data for the notched plate, with a circular hole, made of puddle iron from the Eiffel bridge [10].

GENERAL PROCEDURE TO GENERATE p -S-N-R FIELDS FOR NOTCHED DETAILS

Description of the procedure

The procedure proposed by Correia et al. [1] to derive probabilistic S-N-R fields for notched structural details or mechanical components is based on the assumption that crack path is discretized into elementary material blocks of length q^* , placed along the assumed crack path (see Fig. 1). The process is then pictured according to the following steps:

1. Estimation of the p -SWT-N or p - ϵ_a -N material fields, as described in next section, using experimental fatigue data from smooth specimens. These probabilistic fields will be the basis of the proposed model to evaluate the probabilistic S-N fields of the notched details. The selection of the damage parameter (SWT: Smith-Watson-Topper or ϵ_a : strain amplitude) will depend on material/detail sensitivity to the mean stress or stress ratio.
2. Estimation of the elementary material block size, q^* , using fatigue crack propagation data from fatigue crack propagation tests as for example using CT specimens, following the procedure by Noroozi et al. [2,3]. The elementary material block size is estimated using an iterative optimization procedure in order to result a good fit of the experimental fatigue crack propagation data, for several stress ratios, within the estimated S-N field.
3. Elastoplastic analysis of the uncracked detail in order to evaluate the average local stresses and strains at the first element block size ahead of the notch root. This step was performed in this research, using the finite element method (see Fig. 2).
4. Application of the p -SWT-N or p - ϵ_a -N fields to derive the p -S- N_i -R field representative of the macroscopic crack initiation, in the structural detail/mechanical component, which corresponds to the failure of the first elementary material block in the notch root.
5. Application of a modified version of the UniGrow model to evaluate the fatigue crack propagation in the structural detail, using the elementary material block size computed previously on step 2. The residual stress field required in the UniGrow model is computed in this paper using elastoplastic finite element analysis.
6. Computation of the p -S- N_p -R field corresponding to the fatigue crack propagation in the notched detail/mechanical component (see Fig. 3).
7. Combination of probabilistic fields from steps 4 and 6 to evaluate the global p -S- N_f -R field for the detail under analysis.

The procedures adopted to compute the probabilistic S- N_i -R and S- N_p -R fields, for structural details are summarized in Figs. 2 and 3, respectively [1,5].

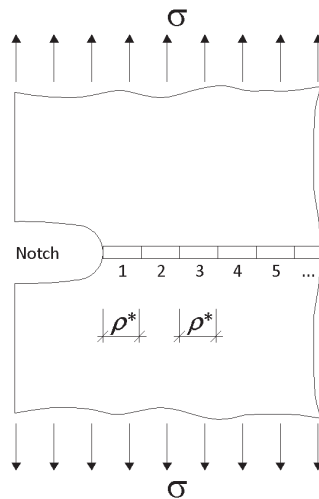

Figure 1: Representative material blocks along the postulated crack propagation path of a notched detail.

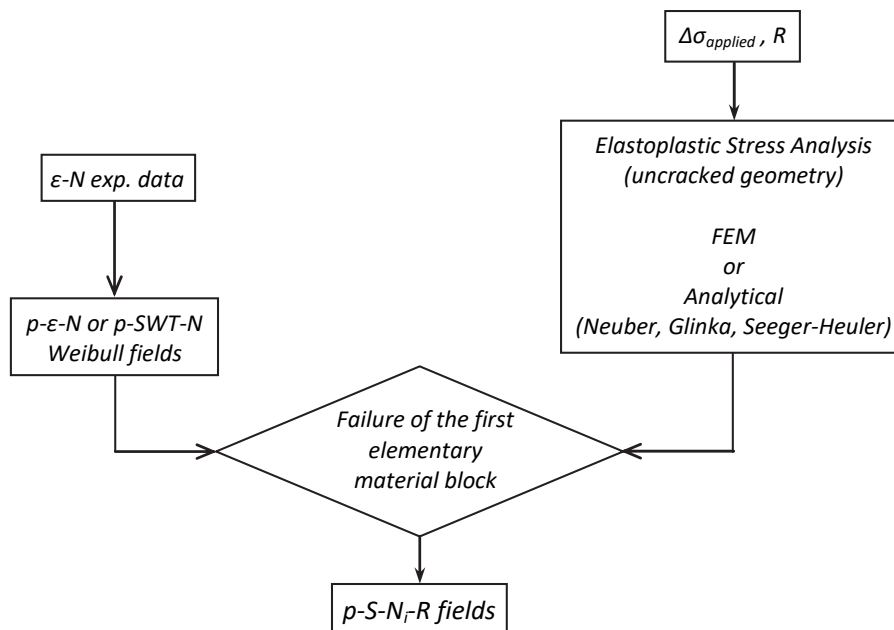

Figure 2: Procedure for the estimation of the probabilistic fatigue crack initiation field for notched geometries.

Additional considerations on the application of the UniGrow model

The *UniGrow* model was proposed by Noroozi et al. [2] to compute the elastoplastic stresses and strains at the elementary material blocks ahead of the crack tip, and was further developed in the current study, particularly in what concerns the determination of the number of cycles to failure of the elementary material blocks, in the fatigue crack propagation regime, according to the following procedure:

- i) The stress intensity factors are determined for the detail under investigation using linear elastic finite element analysis and the J-integral method.
- ii) The original procedure for the computation of the residual stress distribution consisted in the following actions:
 - a) Elastic stress fields ahead of the crack tip are estimated using analytical solutions for a crack with a tip radius, ρ^* , and using the stress intensity factors solutions from analytical formulae.
 - b) The actual elastoplastic stresses and strains, ahead of the crack tip, are computed using Neuber's or Glinka's approach [11,12].
 - c) The residual stress distribution ahead of the crack tip is computed using the maximum actual elastoplastic stresses resulting at the end of the first load reversal and the subsequent cyclic elastoplastic stress range, $\sigma_r = \sigma_{max} - \Delta\sigma$.

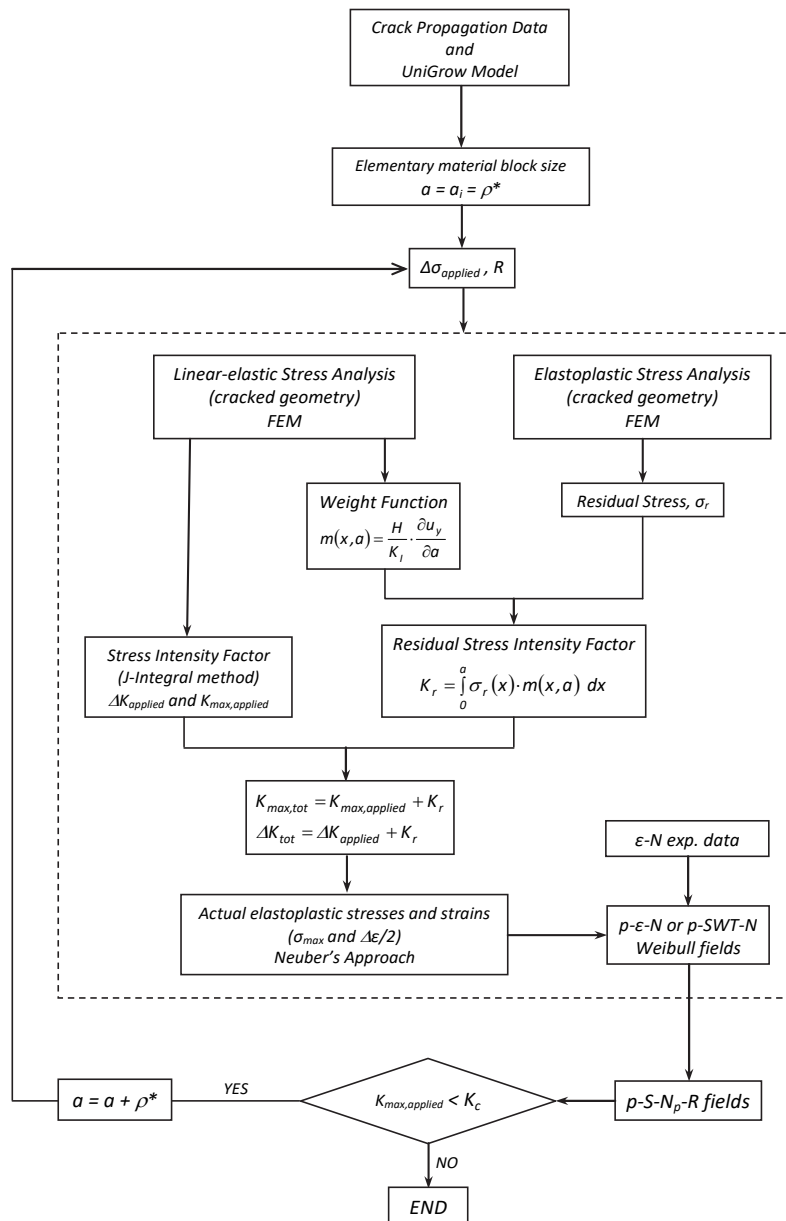

Figure 3. Procedure for the estimation of the probabilistic fatigue crack propagation fields for the notched geometries.

In this study, sub-steps a), b) and c) were replaced by an elastoplastic finite element analysis in order to allow the direct computation of the residual stress fields to be performed.

iii) The residual stress distribution computed ahead of the crack tip is assumed to be applied on the crack faces, behind the crack tip, in a symmetric way with respect to the crack tip. The residual stress intensity factor, K_r , is then computed using the weight function method according to the following general expression [13]:

$$K_r = \int_0^a \sigma_r(x) \cdot m(x, a) dx \quad (1)$$

To this purpose, the weight function $m(x, a)$ was computed for the cracked detail under consideration using the following expression [10]:

$$m(x, a) = \frac{H}{K_1} \cdot \frac{\partial u_y}{\partial a} \quad (2)$$



where $H=E$ (Young's modulus) for generalized plane stress, and $H=E/(1-\nu^2)$ for plane strain, ν being the Poisson's ratio; K_I is the stress intensity factor and u_y is the corresponding crack opening displacement. In this research the weight functions were computed using a linear elastic finite element model for the cracked geometries.

iv) The applied stress intensity factor (maximum and range values) is corrected using the residual stress intensity value, resulting in the total effective values, $K_{max,tot}$ and ΔK_{tot} [2,3]. For positive applied stress ratios, $K_{max,tot}$ and ΔK_{tot} may be computed as follows:

$$\begin{aligned} K_{max,tot} &= K_{max,applied} + K_r \\ \Delta K_{tot} &= \Delta K_{applied} + K_r \end{aligned} \tag{3}$$

where K_r takes a negative value corresponding to the compressive stress field. This residual stress correction makes the crack propagation model sensitive to the stress ratio effects. In fact, the compressive stresses decrease with increasing stress ratio. Consequently, the total stress intensity factors tend to the corresponding applied stress intensity factor. For lower stress ratios, the total stress intensity factors will be lower than the applied ones. This step, corresponding to the original proposal of Noroozi et al. [2] was followed in this study.

v) Using the total values of the stress intensity factors, the above steps ii.a) and ii.b) are applied to determine the updated values of the actual maximum stress and actual strain range for the material representative elements. Then, Smith-Watson-Topper (SWT)-N [14] or Morrow's relations [15] are applied to compute the number of cycles required for the material representative element to fail. For materials with the stress propagation rates more sensitivity to the stress ratio, Smith-Watson-Topper (SWT)-N [14] should be used; otherwise, Morrow's relation [15] may be adequate. Morrow's equation considered here corresponds to the superposition of Basquin [16] and Coffin-Manson relations [17,18] without any mean stress correction.

The *UniGrow* crack propagation model will be applied to compute the number of cycles required to propagate an initial crack at the notch root of a detail until the critical dimension, responsible for the collapse of the component, is achieved. In this research, it is postulated that the crack initiation corresponds to the development of a crack with a size equal to the elementary material block dimension, ρ^* . In addition to the number of cycles required to propagate the crack, the number of cycles required to initiate a crack of a size equal to the elementary material block, ρ^* , will be also computed using a local approach. For this purpose, an elastoplastic stress/strain analysis will be carried out for the uncracked geometry to derive the average stress/strains at the first elementary material block ahead of the notch root (see Fig. 2).

PROBABILISTIC ϵ_a -N AND SWT-N FIELDS

Both crack initiation and crack propagation simulations are based on a fatigue damage relation, which is required to compute the number of cycles to fail the elementary material block. In this paper, probabilistic fatigue models are proposed rather than the deterministic SWT-N or ϵ_a -N models defined by references [14] or [15], respectively. Castillo and Fernández-Canteli [19] proposed a probabilistic ϵ_a -N field, based on the Weibull distribution, which allows the correlation of the experimental strain-life data. Besides the original p- ϵ_a -N field proposed by Castillo and Fernández-Canteli [19], a generalization of the probabilistic field is proposed in this paper, using an alternative damage parameter. In particular, the SWT ($=\sigma_{max}.\epsilon_a$) damage parameter, proposed by Smith-Watson-Topper [14] to account for mean stress effects on fatigue life, was used to generate an alternative probabilistic field, sensitive to mean stress effects. Any combination of maximum stress and strain amplitude that leads to the same SWT parameter should predict the same fatigue life. The SWT-N and ϵ_a -N fields exhibit similar characteristics. Therefore, the p- ϵ_a -N field proposed by Castillo and Fernández-Canteli may be extended to represent the P-SWT-N field as follows:

$$p = F(N^*_f; SWT^*) = 1 - \exp \left\{ - \left[\frac{\log \left(\frac{N_f}{N_0} \right) \cdot \log \left(\frac{SWT}{SWT_0} \right) - \lambda}{\delta} \right]^\beta \right\} \tag{4}$$

$$\log \left(\frac{N_f}{N_0} \right) \cdot \log \left(\frac{SWT}{SWT_0} \right) \geq \lambda$$



where SWT_0 is the fatigue limit defined in terms of the SWT parameter. The new probabilistic field is illustrated in the Fig. 4.

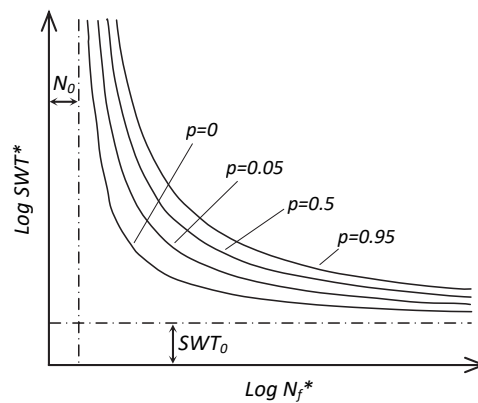

Figure 4: Percentile curves representing the relationship between the dimensionless lifetime, N_f^* , and the damage parameter, SWT^* .

The threshold parameters $\log(N_0)=B$ and $\log(\varepsilon_0)=C$ of the p - ε - N model or $\log(N_0)=B$ and $\log(SWT_0)=C$ of the p - SWT - N model may be estimated using a constrained least squares method. In turn, the Weibull parameters, β , λ and δ , are estimated by the maximum likelihood method. More details about the parameters identification procedure can be found in reference [19].

EXPERIMENTAL FATIGUE DATA OF THE PUDDLE IRON AND NOTCHED DETAIL FROM THE EIFFEL BRIDGE

The puddle iron from the Portuguese Eiffel bridge is considered in this study. The Eiffel bridge was designed by Gustave Eiffel and was inaugurated in 1878 (see Fig. 5). The fatigue behaviour of the material from the Eiffel bridge was determined based on fatigue tests of smooth specimens and fatigue crack propagation tests. The fatigue tests of smooth specimens were carried out according to the ASTM E606 standard [20], under strain controlled conditions and are summarized in Tabs. 1 and 2.



Figure 5: Riveted metallic Eiffel bridge in Viana do Castelo (Portugal).

The fatigue crack propagation tests were performed using CT specimens, in accordance with the procedures of the ASTM E647 standard [21], under load controlled conditions. CT specimens from the Eiffel bridge were defined with a width, $W=40$ mm, and a thickness, $B=4.5$ mm. The fatigue crack propagation tests were performed for stress R-ratios, $R=0.1$



and $R=0.5$. The experimental fatigue data is plotted in Fig. 6, along with the regression lines, for each stress R-ratio, which were defined according to the Paris's law [22]. The fatigue crack propagation data of the material from the Eiffel bridge shows important scatter due to the significant amount of heterogeneities that characterizes the puddle irons [23]. Details about the properties evaluation can be found in reference [24].

E (GPa)	ν	f_u (MPa)	f_y (MPa)	K' (MPa)	n'
193.11	0.30	342.0	292.0	645.95	0.0946

Table 1: Monotonic and cyclic elastoplastic properties of the material from the Eiffel bridge.

σ'_f (MPa)	b	ϵ'_f	c
602.5	-0.0778	0.1595	-0.7972

Table 2: Morrow constants of the material from the Eiffel bridge.

The observation of the Fig. 6b) reveals that the material fatigue crack propagation rates are sensitive to the stress ratio. Due to this result, the fatigue crack propagation rates for this material will be modelled using the *UniGrow* model based on the SWT damage parameter.

Using the experimental fatigue data from the smooth specimens, the p - ϵ_a - N and p -SWT- N fields of the material from the Eiffel bridge were evaluated and presented in Figs. 7 and 8, respectively. The constants of the Weibull field are also included in the figures, in particular the threshold constants (B and C) and the Weibull parameters (β , λ and δ). The Weibull field shows a hyperbolic behaviour with the horizontal asymptote representing the fatigue limit of the material.

A plate with a circular hole, made of puddle iron from the Eiffel bridge, as illustrated in Fig. 9, was considered in this investigation. This geometry was fatigue tested under remote stress controlled conditions, for stress R-ratio equal to 0. The S-N results presented in this sub-section were obtained using fatigue tests of specimens subjected to load controlled conditions, for stress R-ratio equal to 0, and performed on a servo-hydraulic machine rated to 100kN at test frequencies, f , ranging between 5 and 10Hz. A total of 15 specimens were tested. The respective fatigue data can be found in Fig. 10 [10]. The stress range plotted in Fig. 10 corresponds to the net stress range computed at the central section of the plate. The p -SWT- N field will be used to model the fatigue crack initiation and propagation fields for the notched structural detail.

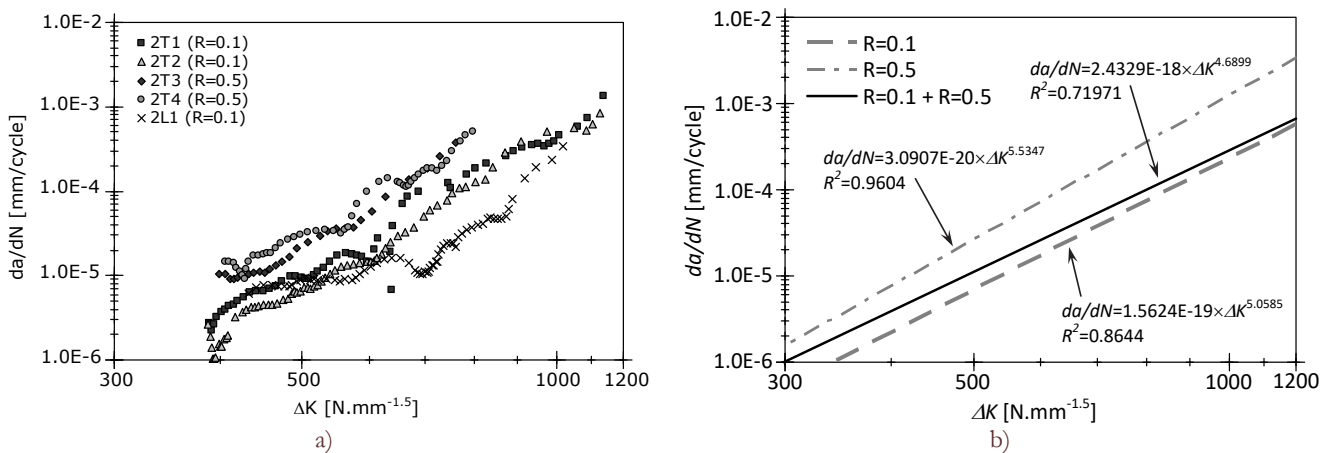

Figure 6: Fatigue crack propagation data of the material from the Eiffel bridge for distinct stress ratios: a) experimental data; b) trend lines for each stress R-ratio.

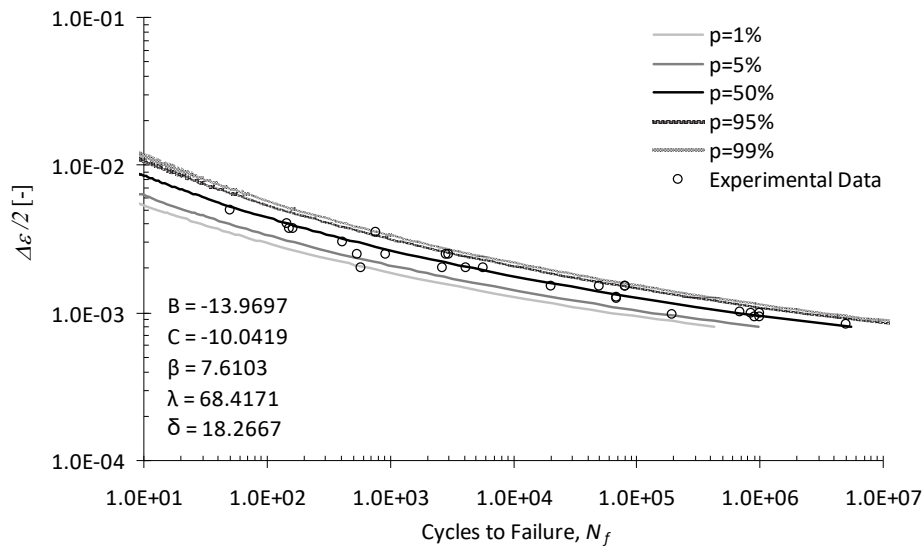

Figure 7: p - ε_a - N field for the material from the Eiffel bridge.

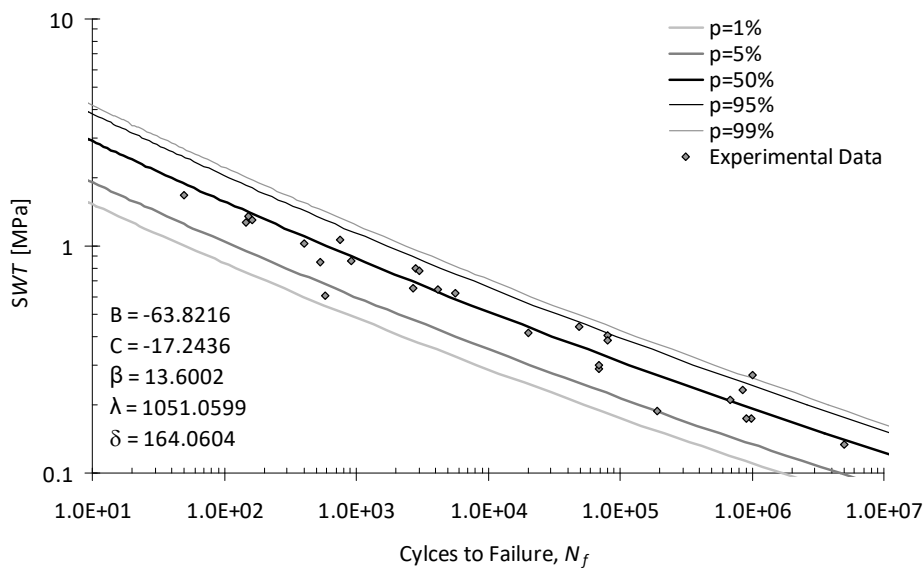

Figure 8: p - SWT - N field for the material from the Eiffel bridge.

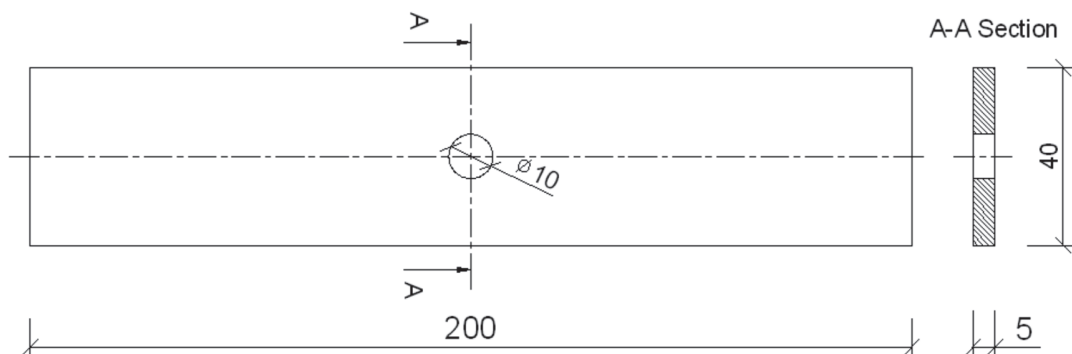

Figure 9: Plate made of puddle iron from the Eiffel bridge with a circular hole (dimensions in mm).

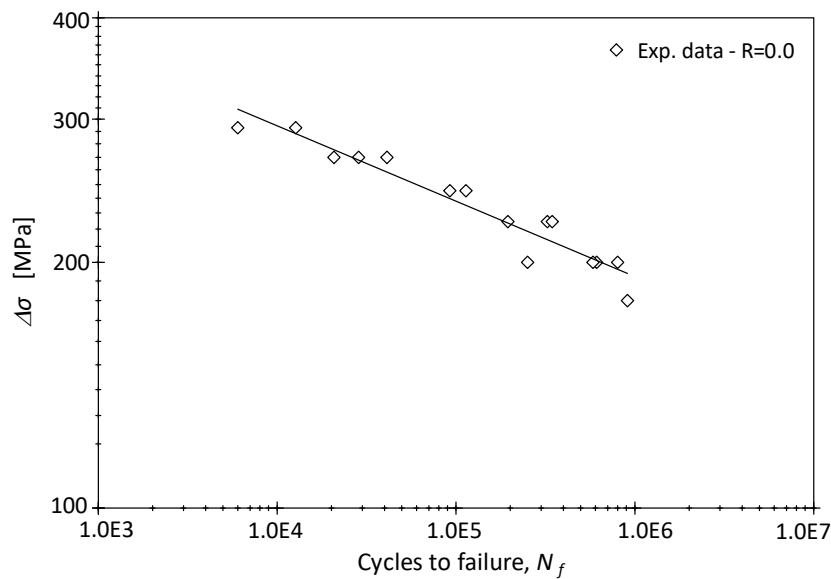

Figure 10: S-N data of the plate with a circular hole made of puddle iron from the Eiffel bridge.

PREDICTION OF THE PROBABILISTIC S-N FIELD FOR A NOTCHED DETAIL

In this section the probabilistic S-N field of the notched detail is computed. The total number of cycles to failure is assumed to follow the following split relation:

$$N_f = N_i + N_p \quad (5)$$

The crack initiation corresponds to the initiation of a crack of a size equal to the elementary material block size, ρ^* . The number of crack propagation cycles corresponds to the number of cycles required to propagate the initial crack with the size of the elementary material block until failure, i.e. unstable crack propagation. The crack initiation is modelled using the p -SWT-N field, due to the sensitivity of the material to the stress ratio, which is visible on the fatigue crack propagation rates. The crack propagation will be performed using the so-called *UniGrow* model, using probabilistic fatigue damage fields. The value of the elementary material block size, $\rho^*=12\times 10^{-4}\text{m}$, was estimated in the reference [9], using fatigue crack propagation data from CT specimens.

Finite element analysis of the notched detail

A 2D finite element model of the notched detail was proposed, using ANSYS® code [25]. Fig. 11 illustrates a typical finite element mesh of the detail, with and without a crack. This mesh exhibits a crack on the left side of the notch. In the practice, cracks started at both sides of the notch root and propagated symmetrically in the plate. Taking into account the existing symmetry planes, only $1/4$ of the geometry is modelled. Plane stress quadratic triangular elements were used in the analysis due to the limited specimen thickness. The PLANE 181 elements were used in the analysis of the notch plate from the Eiffel bridge. A highly refined mesh at the crack tip region was used in order to model the crack tip notch radius, ρ^* (see magnification in Fig. 11). The von Mises yield criterion with multilinear kinematic hardening, was used in simulations aiming an estimation of the residual stresses. The plasticity model was fitted to the stabilized cyclic curve of the material, see Fig. 12.

Prediction of the probabilistic S-N_i-R field

The p -SWT-N model is used to predict the fatigue crack initiation (failure of the first elementary material block) at the notch root of the detail – according to the procedure illustrated in Fig. 2. An elastoplastic finite element analysis was used to compute the stress/strain history at the notch root. In order to facilitate the strain amplitude computation, loading followed by unloading steps were simulated using a plasticity model identified with the stabilised cyclic stress-strain curve of the material. Fig. 13 shows the p -S-N_i field corresponding to the fatigue crack initiation for the detail, for R=0.0. The

analysis of the figure reveals that fatigue crack initiation is dominant, since it gives already a good description of the $S-N$ fatigue data of the detail.

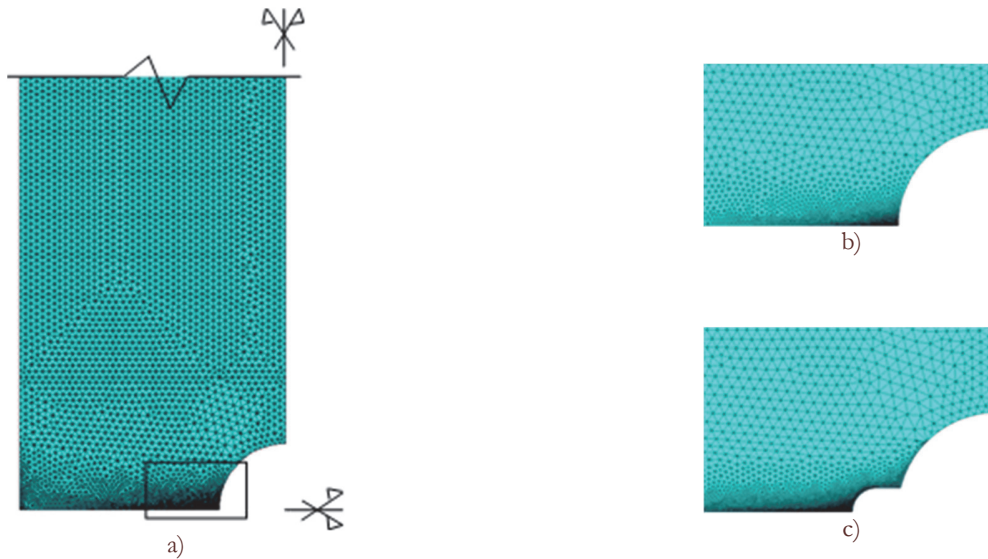

Figure 11: Finite element mesh of the plate with a circular hole: a) $\frac{1}{4}$ of the finite element mesh of the structural detail; b) without crack; c) with a side crack and tip notch radius of $1200\mu\text{m}$.

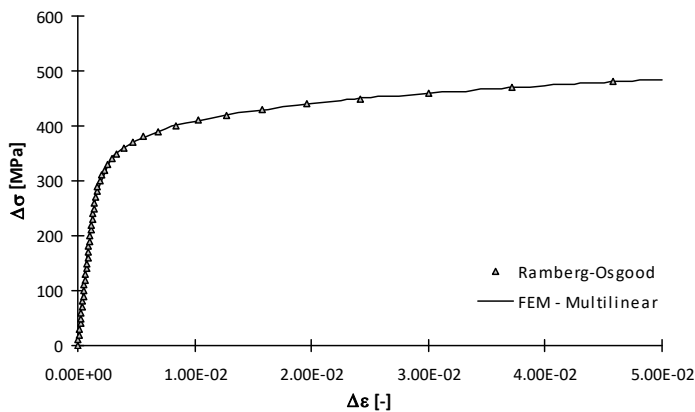

Figure 12: Cyclic curve of the material from Eiffel bridge.

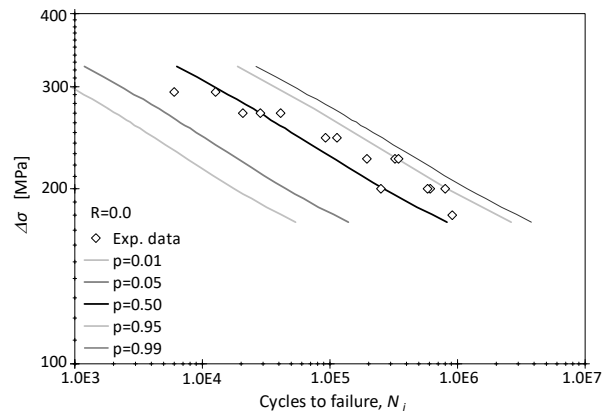

Figure 13: p - $S-N_i$ field for the structural detail made of material from the Eiffel bridge.

Prediction of the probabilistic $S-N_p$ - R field

The procedure adopted to compute the probabilistic $S-N_p$ field for the notched plate is illustrated in the Fig. 3. A value of the elementary material block size, $\varrho^*=12 \times 10^{-4}\text{m}$, was previously estimated using an independent identification based on pure fatigue crack propagation data (see reference [9] for details). Finite element models of the detail were used to perform elastoplastic stress analyses aiming the computation of the residual stresses. In addition, linear elastic finite element models were used to compute the weight functions required for the residual stress intensity factor computation as well as the stress intensity factor solutions for the notched geometry. The stress intensity factors were determined based on a linear-elastic finite element analysis using the J-integral method. Fig. 14 presents the stress intensity factor evolution with the crack length for a unit remote stress, which was used to determine the $\Delta K_{\text{applied}}$. Fig. 15 presents the elastoplastic stress distribution along the y direction, ahead of the crack tip, and obtained at the end of the first load reversal using an elastoplastic finite element analysis. Fig. 16 presents the residual stress distribution along the y direction ahead of the crack tip, resulting from the elastoplastic finite element analysis. These residual stresses were computed after loading-unloading steps. High compressive stresses are observed at the vicinity of the crack tip. The residual stress intensity factor, K_r , was



determined using the weight functions technique as proposed by Eq. (1) and Eq. (2) and using results from linear elastic finite element analysis. Those weight functions allow the residual stress intensity factor, K_r , to be computed. Fig. 17 shows the evolution of K_r with the applied stress intensity factor range. The resulting data shows a good linear correlation.

The p - S - N_p field of the structural detail was calculated for $R=0$ using the p - SWT - N field of the material from the Eiffel bridge together with the *UniGrow* model proposed by Noroozi et al. [2], and assuming $\rho^*=12 \times 10^{-4}m$ (see reference [9]). The use of the p - SWT - N field of the material from the Eiffel bridge to model the fatigue crack propagation is justified by the fact that the material showed a crack propagation rate sensitivity to stress ratio effects as argued in Reference [9]. Fig. 18 illustrates the p - S - N_p field obtained for the structural detail under consideration. The comparison of the experimental fatigue data with the crack propagation field shows that the crack propagation, despite not negligible, is not the dominant damage process, at least for low stress ranges/ high fatigue lives.

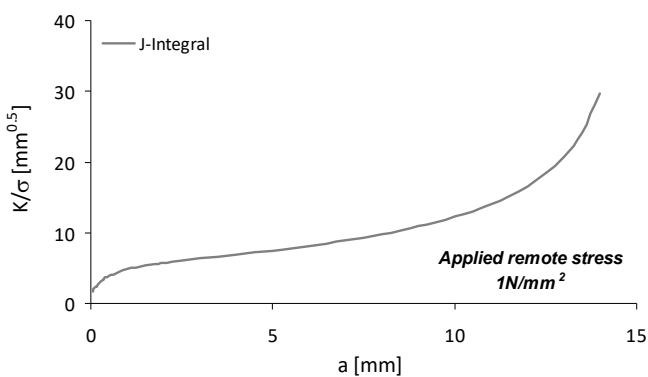

Figure 14: Stress intensity factors as a function of the crack length, for a unit load (elastic analysis).

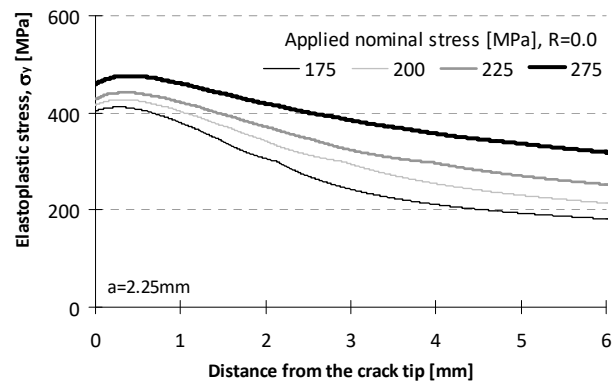

Figure 15: Elastoplastic stress distributions along y (load) direction for the notched plate, for crack size equal to 2.25 mm.

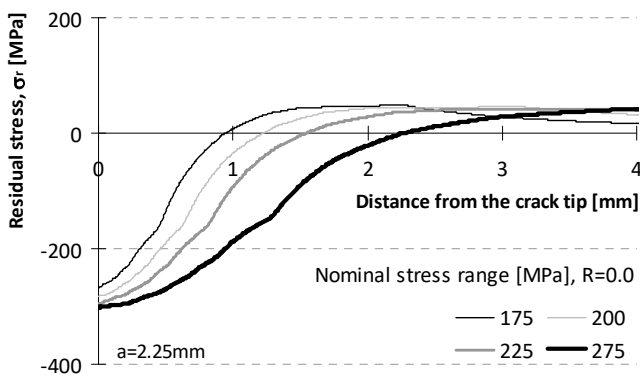

Figure 16: Residual stress distributions for the notched plate for crack size equal to 2.25mm.

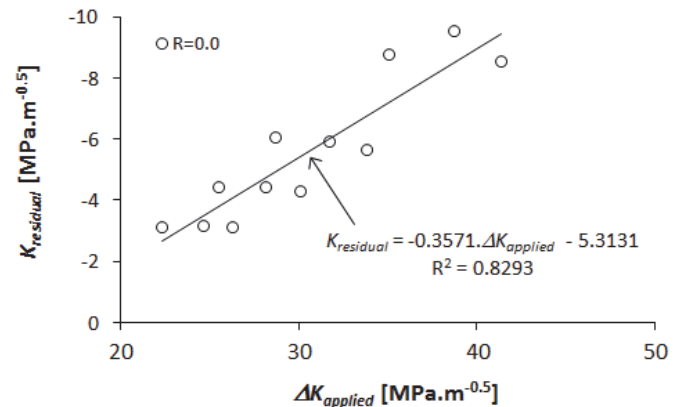

Figure 17: Residual stress intensity factor as a function of the applied stress intensity factor range for the notched plate.

Prediction of the probabilistic S - N - R field

The combined crack initiation and crack propagation S - N fields were computed for the notched plate, using Eq. (5). Fig. 19 presents the combined (superimposed) results. The analysis of the resulting S - N field highlights the accuracy of the proposed methodology. The experimental fatigue data falls inside the 5%-95% failure probability band. The unified approach proposed by Correia et al. [1] seems to give fairly promising predictions for notched components [10], in this case a plate with a circular hole.

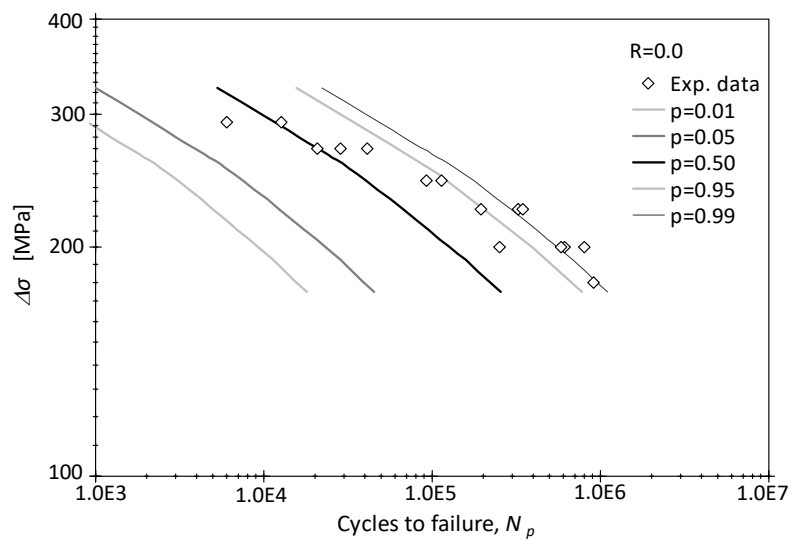

Figure 18: p-S- N_p field obtained for the notched plate made of material from the Eiffel bridge.

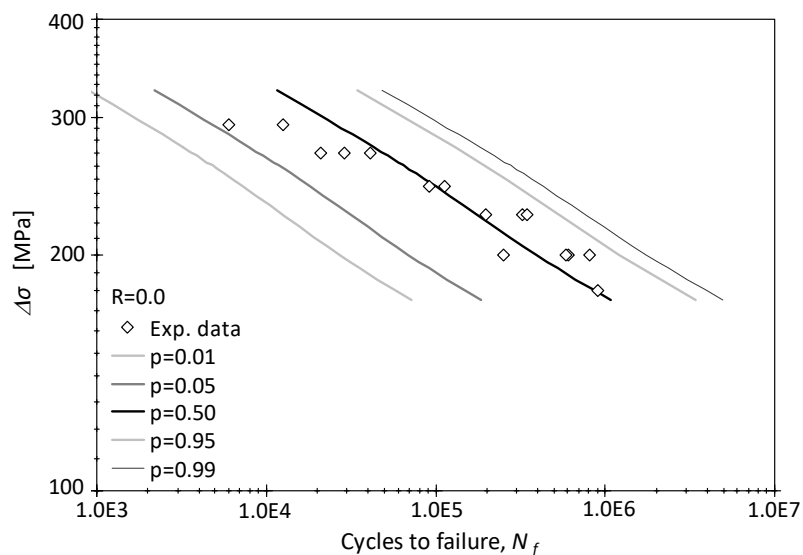

Figure 19: p-S- N_f field obtained for the notched plate made of material from Eiffel bridge.

CONCLUSIONS

A unified approach to derive probabilistic S-N fields proposed by Correia et al. [1] for structural details taking into account both crack initiation and crack propagation was applied in this paper. This approach combines finite element analyses with the UniGrow model and probabilistic fatigue damage fields of the base material. One key parameter in this approach is the definition of the elementary material block size, which was identified using an independent procedure based on pure fatigue crack propagation data. The predicted p-S- N_i field for fatigue crack initiation on the structural detail, based on the p-SWT-N model and elastoplastic finite element analysis provided a good agreement with the experimental results, for R=0. The adaptation of the UniGrow model allowed to reproduce satisfactorily crack propagation prediction using residual compressive stress estimation, based on elastoplastic finite element analysis of the notched detail, and the p-SWT-N damage model. In this study, and for the plate with the circular hole the crack initiation was the dominating fatigue damaging process, while the fatigue crack propagation exerts a small influence on global predictions of the P-S-N field, mainly in the high-cycle fatigue regime. The procedure proposed to derive the probabilistic S-N curves for structural details shows satisfactory results and proved to be quite efficient since it



can be used to reduce the need for extensive testing of structural components. Only small-scale testing data is required, fundamentally fatigue data from smooth specimens will be enough. In addition, the representative material block size needs to be calibrated for the material and for that purpose the use of pure fatigue crack propagation data will be the most adequate choice.

ACKNOWLEDGEMENTS

The authors acknowledge the Portuguese Science Foundation (FCT) for the financial support through the postdoctoral Grant SFRH/BPD/107825/2015. The authors gratefully acknowledge the funding of SciTech: Science and Technology for Competitive and Sustainable Industries, R&D project cofinanced by Programa Operacional Regional do Norte (NORTE2020), through Fundo Europeu de Desenvolvimento Regional (FEDER).

REFERENCES

- [1] Correia, J. A. F. O., De Jesus, A. M. P., Fernández-Canteli, A. Local unified probabilistic model for fatigue crack initiation and propagation: application to a notched geometry, *Engineering Structures*, 52 (2013) 394-497.
- [2] Noroozi, A. H., Glinka, G., Lambert, S., A two parameter driving force for fatigue crack growth analysis, *International Journal of Fatigue*, 27 (2005) 1277-1296.
- [3] Noroozi, A. H., Glinka, G., Lambert, S., A study of the stress ratio effects on fatigue crack growth using the unified two-parameter fatigue crack growth driving force, *International Journal of Fatigue*, 29 (2007) 1616-1633.
- [4] Mikheevskiy, S., Glinka, G., Elastic-plastic fatigue crack growth analysis under variable amplitude loading spectra, *International Journal of Fatigue*, 31 (2009) 1828-1836.
- [5] Correia, J. A. F. O., De Jesus, A. M. P., Fernández-Canteli, A., A procedure to derive probabilistic fatigue crack propagation data, *International Journal of Structural Integrity*, 3 (2012) 158.
- [6] Hafezi, M. H., Abdullah, N. N., Correia, J. A. F. O., de Jesus, A.M.P., An assessment of a strain-life approach for fatigue crack growth, *International Journal Structural Integrity*, 3 (2012) 344-376.
- [7] De Jesus, A. M. P., Correia, J. A. F. O., Critical assessment of a local strain-based fatigue crack growth model using experimental data available for the P355NL1 steel, *Journal of Pressure Vessel Technology*, 135(1) (2013) 011404:1-9.
- [8] Correia, J. A. F. O., De Jesus, A. M. P., Ribeiro, A. S., Strain-based approach for fatigue crack propagation simulation of the 6061-T651 aluminum alloy, *International Journal of Materials and Structural Integrity* (In press).
- [9] Correia, J. A. F. O., De Jesus, A. M. P., Fernández-Canteli, A., Calçada, R. A. B., Modelling probabilistic fatigue crack propagation rates for a mild structural steel, *Frattura ed Integrità Strutturale*, 31 (2015) 80-96.
- [10] Correia, J. A. F. O., De Jesus, A. M. P., Fernández-Canteli, A., Calçada, R. A. B., Probabilistic fatigue behaviour of structural details of puddle iron from the Eiffel bridge, *Proceedings of the 3.º Congresso de Segurança e Conservação de Pontes (ASCP'13)*, (2013).
- [11] Neuber, H., Theory of stress concentration for shear-strained prismatic bodies with arbitrary nonlinear stress-strain law, *Journal of Applied Mechanics. Transactions ASME*, 28 (1961) 544-551.
- [12] Molski, K., Glinka, G., A method of elastic-plastic stress and strain calculation at a notch root, *Materials Science and Engineering*, 50 (1981) 93-100.
- [13] Ma, C.-C., Huang, J.-I., Tsai, C.-H., Weight Functions and Stress Intensity Factors for Axial Cracks in Hollow Cylinders, *Journal Pressure Vessel Technology*, (1994) 116-423.
- [14] Smith, K. N., Watson, P., Topper, T. H., A Stress-Strain Function for the Fatigue of Metals, *Journal of Materials*, 5(4) (1970) 767-78.
- [15] Morrow, J. D., Cyclic plastic strain energy and fatigue of metals, *Int. Friction, Damping and Cyclic Plasticity. ASTM STP 378*, (1965) p. 45-87.
- [16] Basquin, O. H., The exponential law of endurance tests. *Proc. Annual Meeting American Society for Testing Materials*, 10 (1910) 625-630.
- [17] Coffin, L.F., A study of the effects of the cyclic thermal stresses on a ductile metal. *Trans ASME* 76 (1954) 931-950.
- [18] Manson SS. Behaviour of materials under conditions of thermal stress, NACA TN-2933. National Advisory Committee for Aeronautics, (1954).
- [19] Castillo, E., Fernández-Canteli, A., *A Unified Statistical Methodology for Modeling Fatigue Damage*. Springer (2009).



- [20] ASTM E606: Standard Practice for Strain-Controlled Fatigue Testing, Annual Book of ASTM Standards. ASTM, West Conshohocken, PA, USA, 03.01 (1998)
- [21] ASTM E647: Standard Test Method for Measurement of Fatigue Crack Growth Rates, Annual Book of ASTM Standards. ASTM, West Conshohocken, PA, USA, 03.01 (2000)
- [22] Paris, P. C., Gomez, M., Anderson, W. E., A rational analytic theory of fatigue, *Trend Engineering*, 13 (1961) 9-14.
- [23] Lesiuk, G., Szata, M., Bocian, M., The mechanical properties and the microstructural degradation effect in an old low carbon steels after 100-years operating time, *Archives of Civil and Mechanical Engineering*, 15(4) (2015) 786-797.
- [24] De Jesus, A. M. P., Silva, A. L. L., Figueiredo, M. V., Correia, J. A. F. O., Ribeiro, A. S., Fernandes, A. A., Strain-life and crack propagation fatigue data from several Portuguese old metallic riveted bridges, *Engineering Failure Analysis*, 17 (2010) 1495–1499.
- [25] SAS, ANSYS, Swanson Analysis Systems, Inc., Houston, Version 12.0 (2011).